

## Table of Contents

### E61 Sports Wagon

Subject	Page
<b>Introduction</b> .....	<b>4</b>
Dimensions .....	5
<b>Suspension</b> .....	<b>6</b>
Air Suspension .....	6
<b>xDrive with DSC8+</b> .....	<b>8</b>
xDrive .....	9
DXC8+ .....	9
System Circuit Diagram .....	10
System Components .....	13
ATC 300 Transfer Case .....	14
Adjusting Levers .....	16
Servomotor with Motor Position Sensor .....	16
Coding Resistor .....	17
Transfer Case Electronic Control Unit .....	17
DXC8+ Control Unit .....	18
Wheel Speed Sensor .....	18
DSC Sensor .....	19
Bus Overview .....	19
Principles of Operation .....	20
Power Flow .....	20
DSC/DXC8+ Control Unit .....	21
Transfer Case (VGSG) Control Unit .....	21
Transfer Case Control .....	22
Tire Tolerance Logic .....	23
Pilot Control .....	24
Traction Control / Driving Dynamics Control .....	26
Limp Home Operation .....	27
Dynamic Stability Control .....	28
ASC-X / ADB-X .....	28
Hill Decent Control (HDC) .....	29
Dry Braking .....	30
Brake Standby .....	31
Automatic Soft Stop .....	32
Fading Compensation .....	33
Drive-off Assistant .....	34

Subject	Page
Service Information	36
Towing	36
Oil, Transfer Case, and Clutch Monitoring	36
Diagnosis	37
Programming (flashing)	37
Warning Indicator Lamps	37
<b>Body</b>	<b>40</b>
Rear Doors	42
Panoramic Glass Sunroof	42
System Components	43
Multi Drive Sunroof Control Module	43
Drive Motors	44
Power Supply and K-CAN Interface	45
Wind Deflector	45
System Operation	45
Floating Headliner	49
Wind Deflector	49
Service	50
Initialization	50
Anti-Trapping Protection	50
Interior	51
Luggage Compartment	51
Luggage Compartment Roller Cover	53
Headliner	55
Seats	56
Front Seats	56
Rear Seats	56
Rear Hatch	58
Automatic Rear Hatch (HKL)	61
System Components	62
Hydraulic System	62
Angle Hall Sensor	63
System Operation	64
Opening and Closing Rear Hatch	64
Operating Rear Hatch Buttons on Outside/Inside	64
Activation Via Remote Control Services (FBD)	64
Secondary or Emergency Operation	64
Adjusting Opening Height of the Tailgate	65
<b>General Vehicle Electrical Systems</b>	<b>66</b>
Bus System	66
Car Communication Computer	67
Antenna Systems	68
Tail Light Cluster	69
Control Unit Locations in Luggage Compartment	71

## E61 Sports Wagon

Model: 530xiT

Production: From April 2005

# OBJECTIVES

After completion of this module you will be able to:

- Know the differences between the E60 and E61
- Know the location of various components in the E61

## Introduction

The E61 is a Touring car based on the E60. This participant's manual mainly deals with differences from the E60 and are of interest for service.

The E61 will be produced as of April of 2005 for the US market. It will be introduced as a 2006 530xiT model.

New for the E60/61 will be:

- New generation engines in both the six cylinder variants (N52) and the eight cylinder variant (N62MU).
- All wheel drive capabilities with the xDrive transfer case only on six cylinder variants. (525xi, 530xi, 530xiT)
- Hydraulically controlled lifting and lowering of rear tailgate (E61 only)
- ARS will not be available on any all wheel drive (AWD) vehicle.
- SMG will NOT be available on an AWD vehicle.
- AFS will NOT be available on an AWD vehicle.

All models are equipped as standard with a 6-speed manual gearbox. A 6-speed automatic transmission with Steptronic is available on request.



## Dimensions

The E61 has grown significantly compared to the E60. This increase in size is quite apparent in the interior: more head and shoulder clearance and a good 4 centimeters more knee space for rear passengers.

in mm	E61	E39/2	Difference
Vehicle length	4843	4805	+ 38
Vehicle width	2026	1981	+ 45
Body width	1846	1800	+ 46
Vehicle height (curb weight with roof antenna)	1491	1445	+ 46

## Suspension

The E61 features an all-aluminium chassis as already introduced on the E60. A variant of the integral link rear axle IV has been developed for the Touring that makes for a completely flat luggage compartment floor while providing a very large through-load space. The 530xiT is equipped with an automatic self-levelling suspension provided by air suspension at the rear axle as standard.

### Air Suspension

The air spring installed in the E61 is similar in operation to the system installed in the E65.

The advantages of an air spring on the rear axle can be felt particularly in vehicles with high payload (such as a sport wagon) as mainly the axle load at the rear axle changes when loading and unloading the car.

With a conventional steel spring, the change in the axle load affects not only the ride height but also the vibration and suspension geometry.

There would also be a change in the camber of the rear axle wheels at high payload - this would result in increased load at the inner shoulders of the tires which in turn would mean reduced load bearing capacity of the tires.

The air springs and dampers are supported independently on the floor pan of the car body.



Rear Air Suspension

In previous air suspension systems the air supply unit was located in the luggage compartment under the spare tire. For the first time, the air supply system (LVA) on the E61 is not located in the vehicle interior but rather on the underbody between the spare wheel well and battery box.

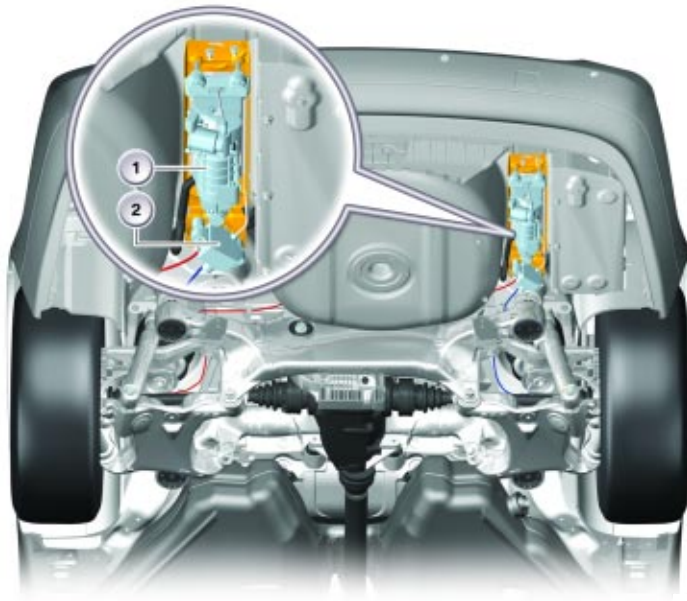

Index	Explanation
1	Pressure accumulator with compressor
2	Valve block

Location of air supply system

Since the air required to raise the vehicle can no longer be drawn from the vehicle interior, air must be taken via a filter from a protected area. The area between the wheel arch paneling of the rear right wheel is used for this purpose.



Location of air filter for LVA

## xDrive with DSC8+

From 04/2005, the BMW 5 Series wagon and sedan (optional) will have all wheel drive capability utilizing the tried and tested all-wheel drive system xDrive of the X3 and X5.

The innovative all-wheel xDrive is a system for controlling and regulating the "infinitely" variable drive torque distribution over the front and rear axle. The xDrive uses the system functions of the DSC to positively influence the vehicle handling by specifically distributing the power in the event of understeer or oversteer.

With the controlled multi-disc clutch in connection with the xDrive it is now possible to resolve the conflict between traction and vehicle handling.

This is been achieved in that the xDrive does not predefine the torque distribution by a fixed transmission ratio as is the case with the previous systems. Instead, distribution of the drive torque is dependent on the clutch lockup torque of the controlled multi-disc clutch in the transfer case and on the transmitted torque at the front and rear axle.

### Driver Benefits

In addition to the previous functions, a series of additional safety and comfort functions will now be available to the driver with the introduction of the DXC8+ in the E60/E61.

The expanded DSC8+ functions include:

- Dry braking
- Brake standby
- Automatic soft-stop
- Fading warning and assistance
- Drive-off assistant
- Hill descent control HDC

Besides the outstanding chassis characteristics of the BMW 5 Series, the all wheel drive system offers traction advantages not only on snow and ice but also on unsurfaced roads.

**Note: Because many system components and functions are shared between the xDrive and DSC8+ system, they will be discussed together in this section.**



## xDrive

The innovative xDrive four-wheel drive is a system that controls and regulates the distribution of driving torque to the front and rear axles. The measured variables of DSC are used by xDrive but are also influenced by modified handling performance.

The multi-disc clutch is the heart of the xDrive. By using the controlled multi-disc clutch, it is possible to resolve the conflict between traction and handling performance.

This is achieved through the fact that torque distribution is not determined by a fixed gear ratio in the xDrive as was the case in the previous systems. Instead, the distribution of driving torque is dependent on the locking torque of the controlled multi-disc clutch in the transfer case and on the transferable torque to the front and rear axles.

## DXC8+

The DXC8+ system adds features to the DSC8 system already in use in the E60 sedan and combines features used in other DXC systems (E53/83). Due to the mechanical composition of the xDrive system, the programming for DSC regulation has also been changed.

### Present DSC8 functions:

- ABS Anti-lock Braking System
- ADB Automatic Differential Brake
- EBV Electronic Braking Force Distribution
- CBC Cornering Brake Control
- ASC Automatic Stability Control
- DSC Dynamic Stability Control
- DBC Dynamic Brake Control
- MSR Engine Drag Torque Control

### Present DXC functions:

- TCC Transfer Case Control  
(control of multi-disc clutch in transfer case)
- ASC-X Automatic Stability Control X  
(special function for all-wheel drive vehicles)
- ADB-X Automatic Differential Brake X  
(special function for all-wheel drive vehicles)
- HDC Hill Decent Control

### New DSC/DXC8+ functions

- Dry braking
- Automatic soft stop
- Drive-off assistant
- Hill descent control HDC
- Brake standby
- Fading assistance
- Trailer stabilization control

System Circuit Diagram

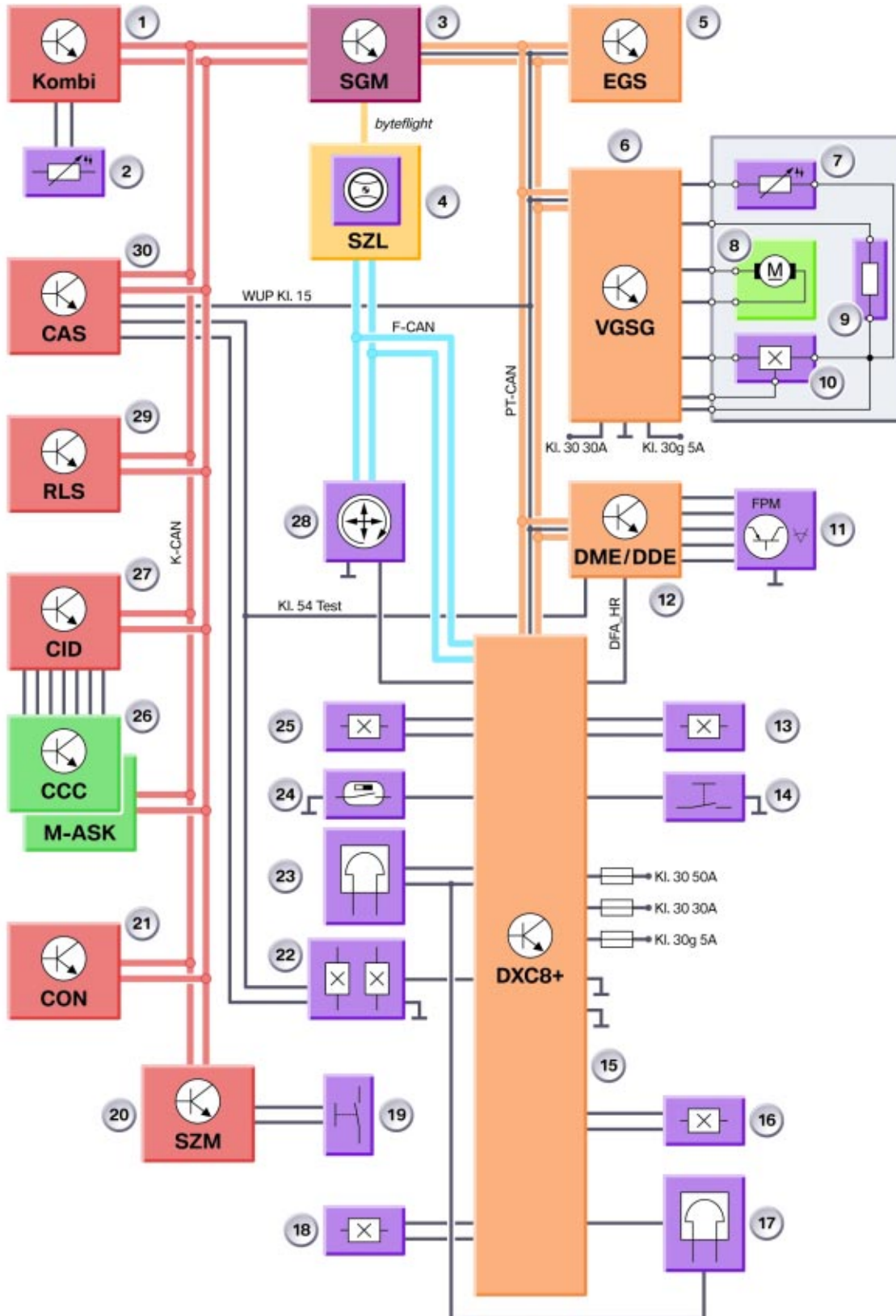

### System Circuit Diagram Legend

Index	Explanation
1	Instrument cluster
2	Outside temperature sensor
3	Safety and gateway module (SGM)
4	Steering column switch cluster (SZL) with HDC button
5	Electronic transmission control module (EGS)
6	Transfer case control unit (VGSG)
7	Temperature sensor
8	Electronic motor, actuator drive
9	Coding resistor
10	Motor position sensor
11	Accelerator pedal module (FPM) - (not for US)
12	Digital motor electronics (DME) control unit
13	Wheel speed sensor, front right
14	Handbrake switch
15	Dynamic traction control (DXC8+)
16	Wheel speed sensor, rear right
17	Brake wear sensor, rear right
18	Wheel speed sensor, rear left
19	DSC button
20	Center console switching center (SZM)
21	Controller (CON)
22	Brake light switch (BLS)
23	Brake wear sensor, front left
24	Brake fluid level sensor
25	Wheel speed sensor, front left
26	CCC or M-ASK
27	Central information display
28	Yaw rate/longitudinal/transverse acceleration sensor (Y-sensor-2)
29	Rain light sensor (RLS)
30	Car Access System (CAS)

NOTES

PAGE

## System Components

The xDrive/DXC8+ system is composed of the following major components:

- ATC 300 transfer case
- Adjusting levers
- Servomotor with motor position and temperature sensor
- Coding/classification resistor
- Transfer case control unit
- DXC8+ control unit
- Wheel speed sensor
- DSC sensor (Y-sensor 2)

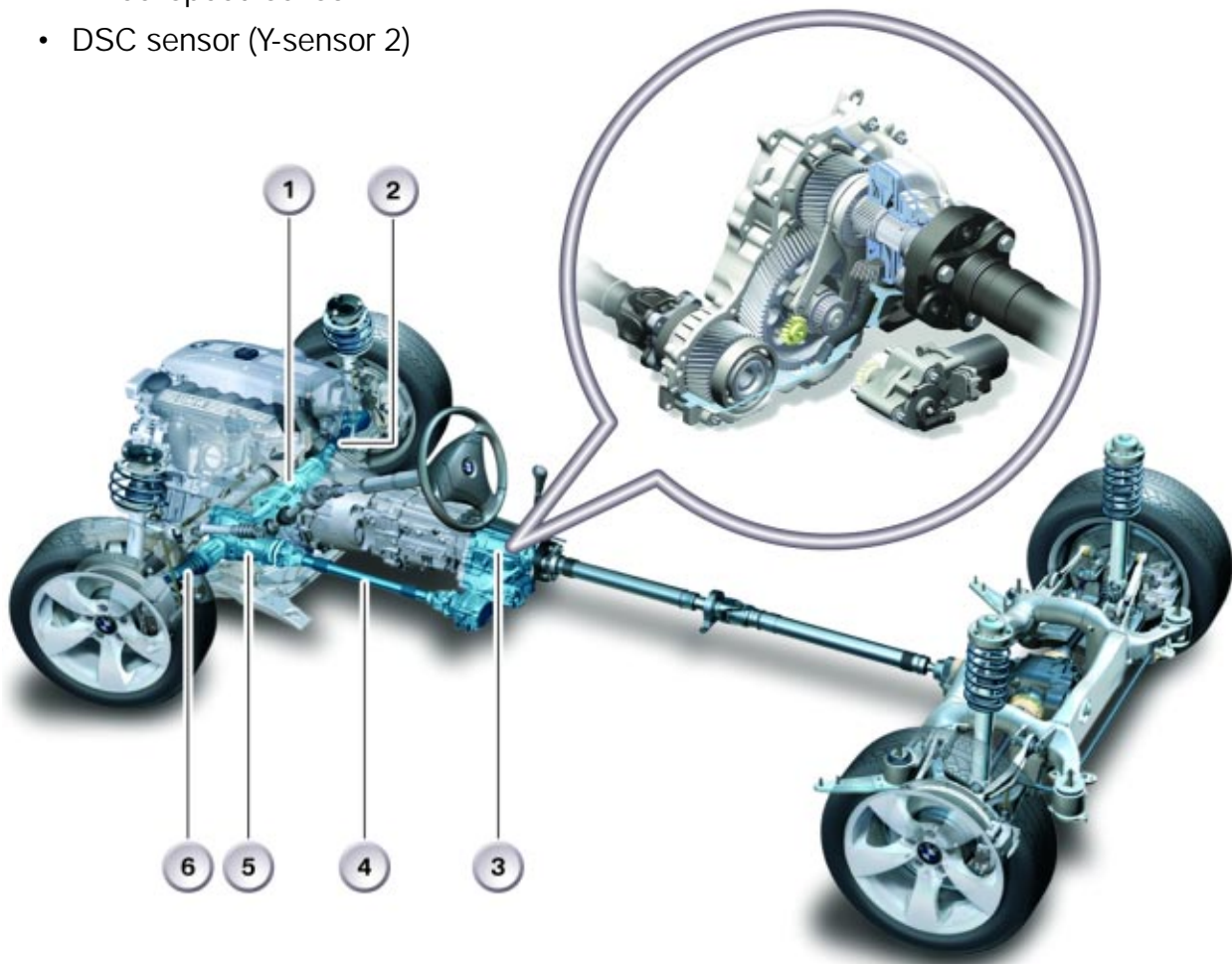

Index	Explanation	Index	Explanation
1	Oil Pan lead through	4	Propeller shaft to front axle
2	Right drive shaft, front	5	Front axle differential
3	Transfer case	6	Left drive shaft, front

### ATC 300 Transfer Case

The transfer case ATC 300 (Active Torque Control) is used on the E60/E61.

In view of the restricted package space of the transmission tunnel in the BMW 5 Series, it was not possible to adopt the transfer case from the BMW X3 (ACT400) with the same torque rating.

On the BMW 5 Series it was not possible to drive the forward power flow diagonally as is the case on the X3 with a chain, but rather it is necessary to divert it L-shaped with the aid of spur gears (pinions), resulting in a modified design of the transfer case.

The actuator drive and the actuation of the control lever were also modified. The clutch package remains unchanged. The forward connection is provided by a bolted on drive shaft.

The flange of the ATC transfer case is the same for automatic and manual transmissions.

### ATC 300 Transfer Case

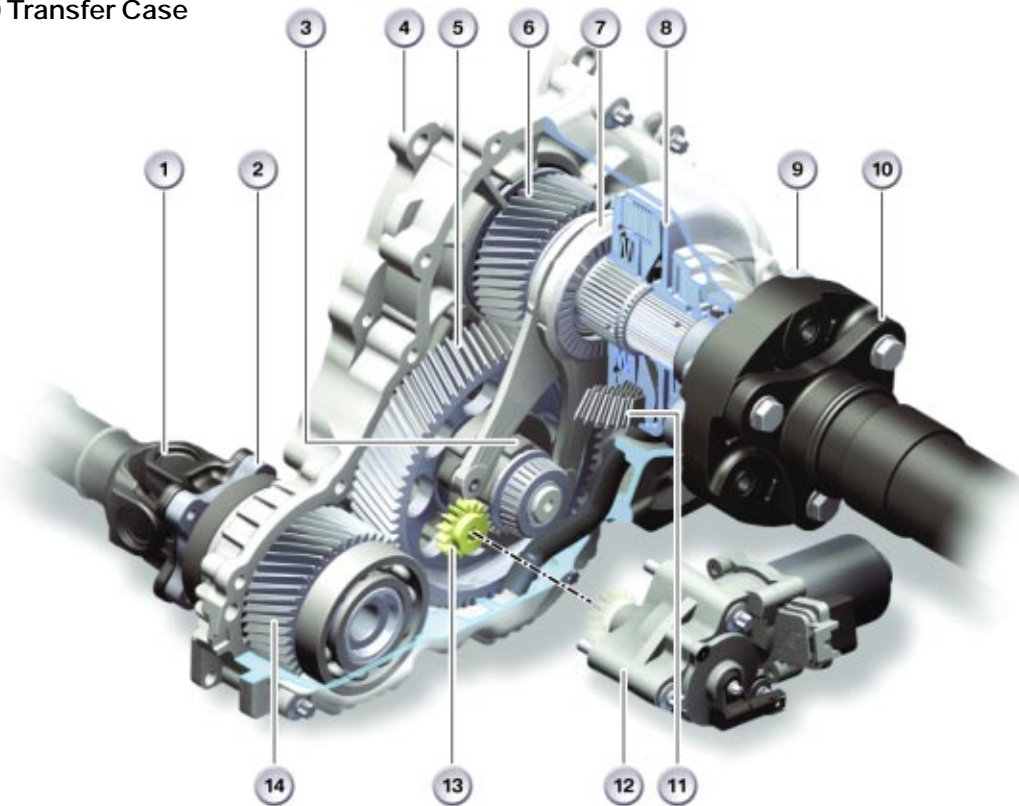

Index	Explanation	Index	Explanation
1	Propeller shaft to front axle	8	Clutch housing
2	Drive flange to front axle	9	Output flange to rear axle
3	Control cam	10	Propeller shaft to rear axle
4	Transfer case	11	Disc package
5	Idler gear	12	Actuator drive
6	Drive gear	13	Drive pinion
7	Control lever	14	Output gear



The ATC 300 is installed in the E61 and E60 all wheel drive models. The ATC 400 is installed in the E83 and the ATC 500 in the E53 MU.

The ATC 300 differs from the other transfer cases because it is gear driven not chain driven. The basic functions and operations remain unchanged.

The difference between the transfer cases are:

- ATC 400 & 500 are chain driven vs. ATC 300 which is gear driven
- ATC 300 & 400 uses a four bolt flange to connect to the front propeller shaft vs. ATC 500 which uses a splined connection
- ATC 500 utilizes one more disc in the multi-disc clutch than the ATC 300 & 400
- ATC 500 has 19mm greater length between the input shaft and the output shaft to the front axle than the ATC 400. (the ATC 300 uses gears not a chain)

#### ATC 500 Transfer Case

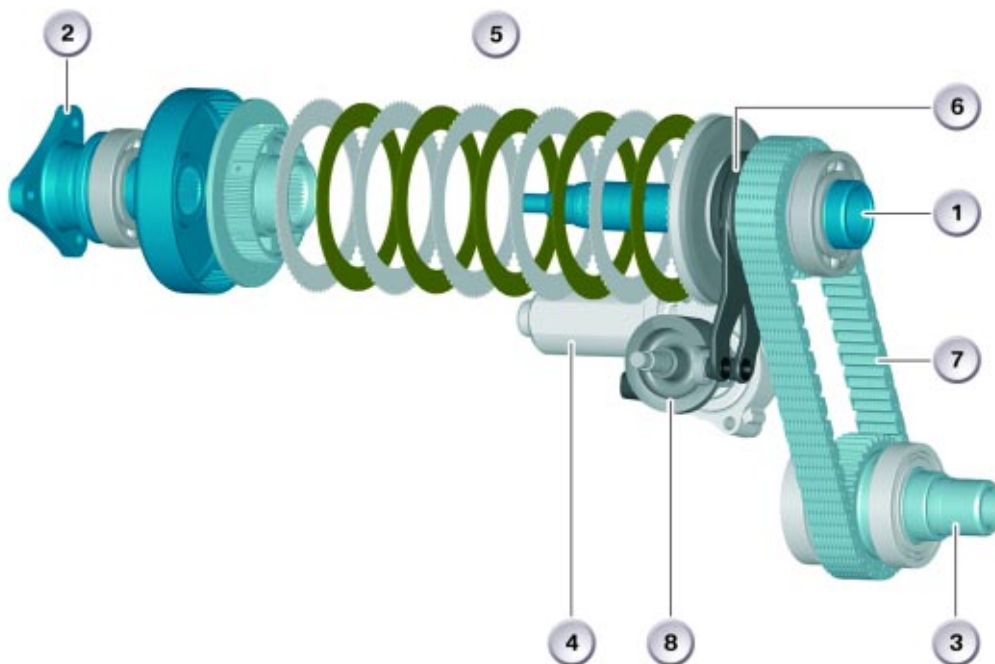

Index	Explanation	Index	Explanation
1	Input from manual / automatic transmission	5	Clutch discs
2	Output to rear axle prop. shaft	6	Adjusting levers with ball ramp
3	Output to front axle prop. shaft	7	Chain
4	Servomotor	8	Disc cam

## Adjusting Levers

The actuator drive unit operates such that the drive pinion rotates and engages via the gearing in the control cam. In turn, the control cam is rotated and the control lever pressed apart.

The rotary motion is converted into an axial force by the ball ramps in the control lever. The axial force that compresses the disc package in the multi-disc clutch is proportional to the transmitted torque of the multi-disc clutch.

The position of the control lever is infinitely variable and allows exact regulation of the control cam by the actuator drive unit.



## Servomotor with Motor Position Sensor

The actuator drive unit is a DC motor with worm drive. It also features a Hall sensor that serves the purpose of determining the position and the adjustment speed of the motor shaft. The position of the motor shaft determines the closing rate of the multi-disc clutch.

There is also a temperature sensor installed in the motor that signals the temperature to the transfer case control unit (VGSG). A temperature model is calculated in the VGSG for the purpose of protecting the motor from overload. For this purpose, the maximum closing rate is reduced in various stages.

If these measures are not sufficient to protect the motor from overload, the control is interrupted and the clutch completely opened so that only rear axle drive is now possible.



Index	Explanation
1	Magnetic ring
2	Motor position sensor (Hall sensor)



### Coding Resistor

Because of mechanical tolerances in production, the characteristic curve of the multi-disc clutch locking torque varies slightly.

Once the actual locking torque has been measured on the clutch test bench, a resistor is attached to the servomotor; the resistor's value is a reference to the locking torque characteristic.

Each time the engine is started, the transfer case control unit measures the resistance value once and the optimum program map for the transfer case fitted is selected.

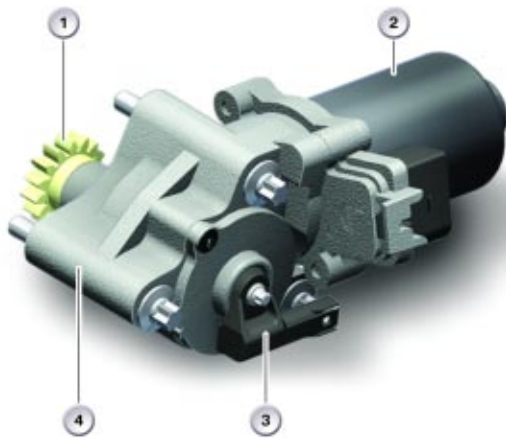

Index	Explanation
1	Drive pinion
2	Electric motor
3	Coding resistor
4	Actuator drive housing

### Transfer Case Electronic Control Unit

The transfer case control unit (VGSG) is on CAN-bus.

Depending on the vehicle, the module is installed in the following location:

- E60/61 - under the rug forward of the passenger's front seat
- E83 (X3) - under the rear floor panel of the cargo compartment trim
- E53 (X5) - under the rear bench on the left side

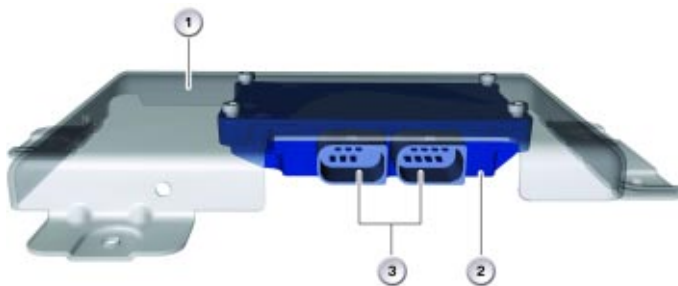

Index	Explanation
1	Kick guard
2	Transfer case control unit
3	Connector

## DXC8+ Control Unit

The DXC8+ control unit is installed in the engine compartment essentially consists of three components:

- Add-on control unit
- Valve block with integrated pressure sensors
- Pump motor

The newly developed changeover valves permit even more exact control in the low pressure range, resulting in the following advantages:

- Reduction of control noise
- Improvement in control quality and control comfort
- Improvement in automatic brake intervention by the active/dynamic cruise control ACC/DCC
- Improvement in the control accuracy of the HDC function
- Realization of additional brake functions

## Wheel Speed Sensor

Active wheel speed sensors with an integrated evaluator circuit are used together with the xDrive.

The active wheel speed sensors require a power supply for their operation. The output signal is sent as a data protocol based on the pulse-width modulation method (PWM). The PWM signal is used for the purpose of determining the road speed. The pulse width contains additional information relating to the direction of rotation, standstill detection, installation position detection, and air gap reserve to the sensor ring. (example : sends one pulse every 0.75 s when the wheel is stationary)

The direction of rotation is determined by the internal signal offset of three correspondingly arranged Hall-effect elements in the sensor.



Index	Explanation
1	Sensor ring
2	Sensor-IC with Hall sensor
3	Sensor housing

## DSC Sensor

The DSC sensor (Y-sensor 2) is installed under the front passenger's seat next to the transmission tunnel.

In addition to the previous yaw rate and transverse acceleration sensor, the DSC sensor also contains an additional longitudinal acceleration sensor for the drive-off assistant function.

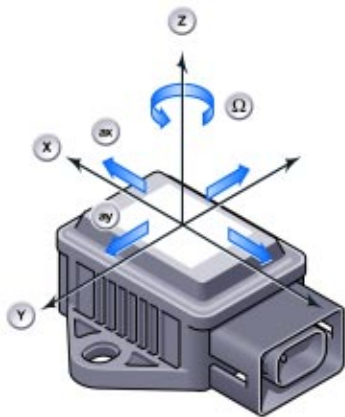

Index	Explanation
X	Longitudinal axis
Y	Transversal axis
Z	Vertical axis
ax	Longitudinal acceleration
ay	Lateral acceleration
$\Omega$	Yaw rate

## Bus Overview

The transfer case control unit (VGSG) is on the PT-CAN. VGSG shares information with DSC for overall xDrive control and has diagnostic communication.

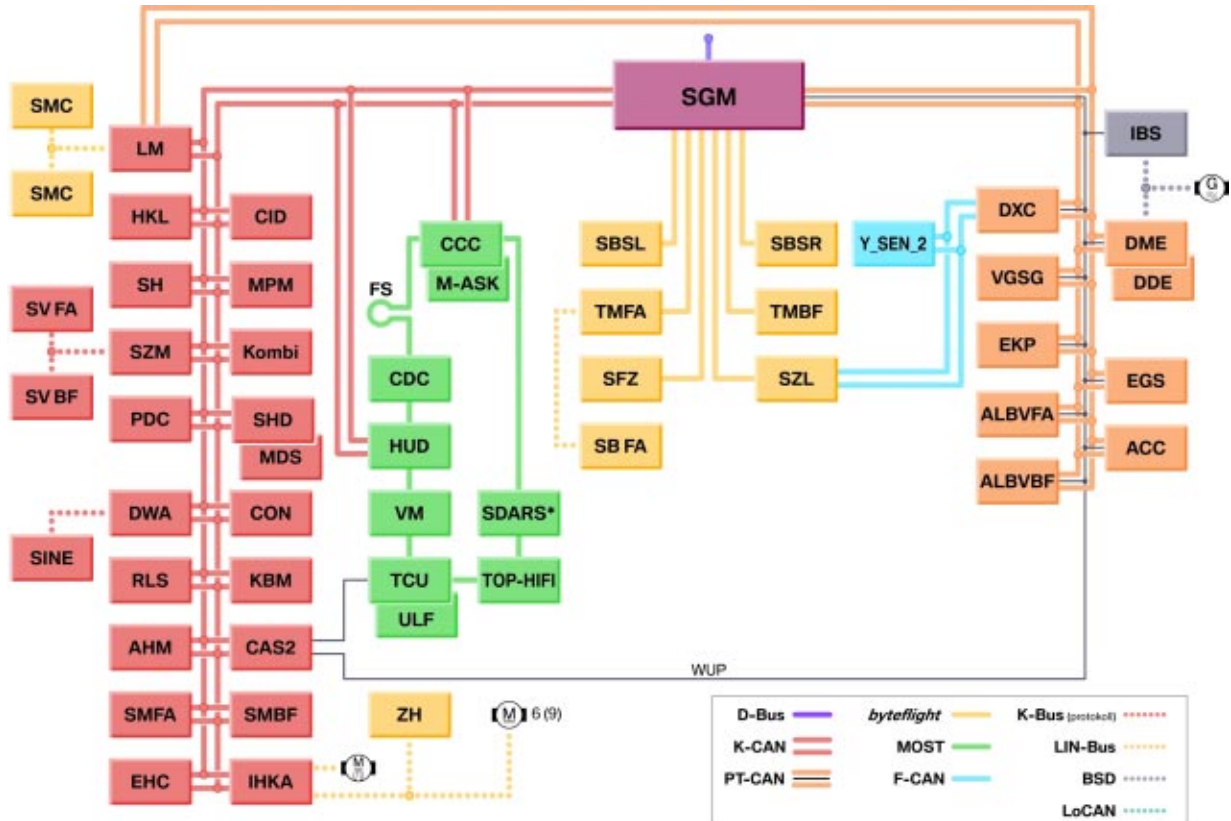

Bus Topology Chart of E61 Sports Wagon (530xiT)

## Principles of Operation

### Power Flow

When the multi-disc clutch in the transfer case is disengaged, no driving torque is transmitted to the front axle. All of the driving torque is then distributed to the rear axle. This is because the input shaft (1) is splined providing a permanent connection to the rear axle propeller shaft output flange (2). The multi-disc clutch couples the rear axle propeller shaft output flange to the front propeller shaft output (3).

The driving torque on the front axle is increased or decreased by regulating the locking pressure of the multi-disc clutch, providing a stepless coupling of the front axle to the drivetrain. This depends on driving situations and road conditions. When the multi-disc clutch is fully engaged, the front and rear axles turn at the same speed.

Driving torque distribution (front/rear) is based on available traction at each axle. For example, when traction is identical on the front and rear axles and a driver accelerates from a stop in first gear at full throttle, the rear axle is capable of sustaining greater driving torque as the vehicle weight shifts from the front to the rear.

Another example is when the front axle is on a high traction surface and the rear axle is on ice. In this case, virtually 100% of the available driving torque is transmitted to the front axle. Based on available traction, virtually no driving torque can be supported by the rear axle. Obviously, when more driving torque is transmitted to the front axle, driving torque on the rear axle is proportionally reduced due to lack of traction.

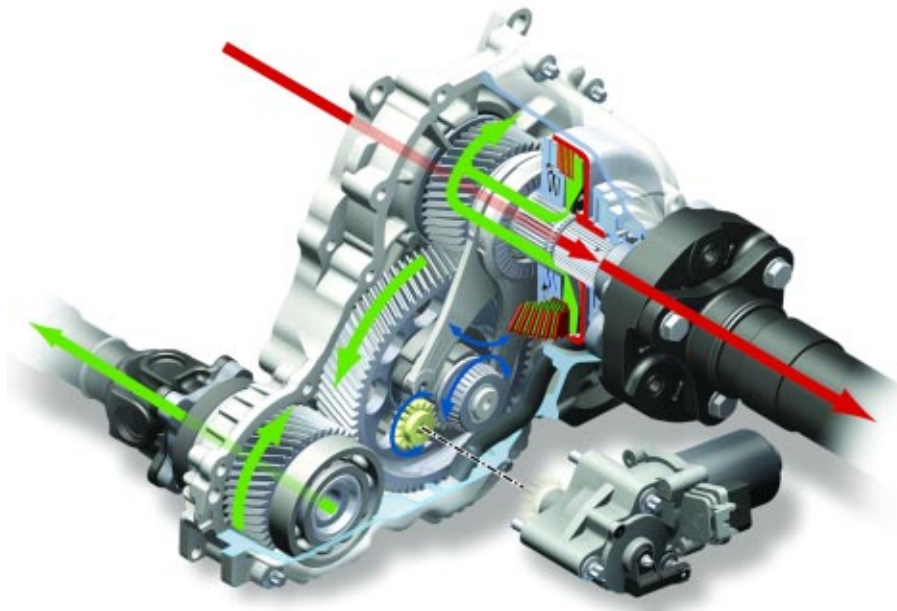

Color	Explanation
Red	Torque from engine to rear axle
Green	Controlled torque to front axle
Dark Blue	Rotation to drive multi-disc clutch

---

## **DSC/DXC8+ Control Unit**

As in the earlier DSC control units, there are two microprocessors incorporated in the add on DSC8+ control unit. The difference is that in the DSC8 and DSC8+ both processors do not calculate the same algorithms but rather one processor is responsible for performing control and monitoring calculations and checking the plausibility of the wheel speeds.

There are also two semiconductor relays integrated in the DSC8+ control unit, one for the pumpmotor and the other for the solenoid valves.

On exceeding a road speed of 6 km/h, an electronic self-test is started, during which the pump motor and all solenoid valves are briefly actuated. If the brake is operated at a driving speed of 6 km/h, as may be the case with "two-foot drivers", the self-test will be performed at a speed of 15 km/h.

The check of the wheel speed signals is already started at a speed of 2.75 km/h.

In connection with the xDrive, the DXC8+ control unit also undertakes the task of calculating the lockup torque for the multi-disc clutch in the transfer case.

The lockup torque is always optimally set and controlled to suit the corresponding driving situation.

The drive torque distribution over the front and rear axles is based on the lockup torque. The lockup torque to be set is derived from the pilot control and from a higher-ranking traction and vehicle dynamics regulator corresponding to the driving situation.

The DXC8+ control unit sends the data, concerning the lockup torque, on the PT-CAN to the transfer case control unit VGSG.

Conversely, the transfer case control unit signals the lockup torque actually set as well as the load on the transmission fluid, electric motor and multi-disc clutch.

## **Transfer Case (VGSG) Control Unit**

The transfer case control unit serves the purpose of regulating the lockup torque of the multi-disc clutch in the transfer case and therefore to distribute the drive forces between the front and rear axle corresponding to requirements.

The transfer case control unit receives the necessary torque request from the DXC8+ control unit and adjusts the currently required clutch lockup torque accordingly.

The function required for this task is the transfer case control (TCC). The control and power electronics circuitry required for the actuator drive is integrated in the transfer case control unit.

The requirement to set the necessary clutch lockup torque is converted to a corresponding rotary movement of the actuator motor. After turning off the engine, a reference run is performed in order to be able to assign a corresponding clutch lockup torque to a defined angle setting of the actuator motor, while also taking into account the effects of wear.

During the course of the reference run, the clutch is fully closed and opened once. The power intake is measured at the respective angle setting of the actuator motor during the

opening and closing operation so as to determine the beginning and end of the clutch closing procedure. The angle setting is determined by means of a Hall sensor integrated in the actuator motor.

A clutch and oil wear model is additionally calculated in the transfer case control unit.

Where necessary, this model limits the lockup torque in order to reduce friction.

In the event of DSC failure, an emergency strategy for driving the transfer case clutch is integrated as a fall-back level in the transfer case control unit in order to maintain all-wheel drive also in this case.

### **Transfer Case Control**

Control of the lockup torque of the multi-disc clutch in the transfer case facilitates infinitely variable coupling of the front axle to the drive train.

As a result, the drive torque at the front axle can be increased or reduced corresponding to the driving situation and the condition of the road. When the torque at the front axle is increased, the drive torque at the rear axle is, of course, reduced by this torque.

The advantages of variable distribution of the drive torque at the front and rear axles are:

- Optimum utilization of the lateral cornering and wheel peripheral forces applied at the front and rear axles.
- Brake interventions by the DSC are required considerably later, thus increasing overall comfort.
- Compared to a transfer case with fixed transmission ratio (open longitudinal differential) and DSC, with xDrive the drive torque distribution is considerably improved in connection with greatly differing friction values at the front and rear axles.

Even when DSC is turned off, TCC is still active to ensure maximum traction and vehicle dynamics.

Permanent all-wheel drive is cancelled to a large extent or completely in only three control situations:

- When negotiating extremely tight corners with little engine torque in order to allow speed equalization between the front and rear axle (e.g. parking)
- At speeds in excess of 180 km/h
- In extreme understeer driving situations

The control algorithm of the transfer case clutch control can be described in three main modules:

- Tire tolerance logic
- Pilot control
- Traction control/vehicle dynamics control

■ **Tire Tolerance Logic**

The tire tolerance logic detects different tread circumferences on the front and rear axles. This occurs when:

- Mixed tires are used
- Space saving spare tire is installed
- Tires are used that have been worn down to different levels

Normally, tire circumference deviations result in drivetrain torque bias (unwanted variations).

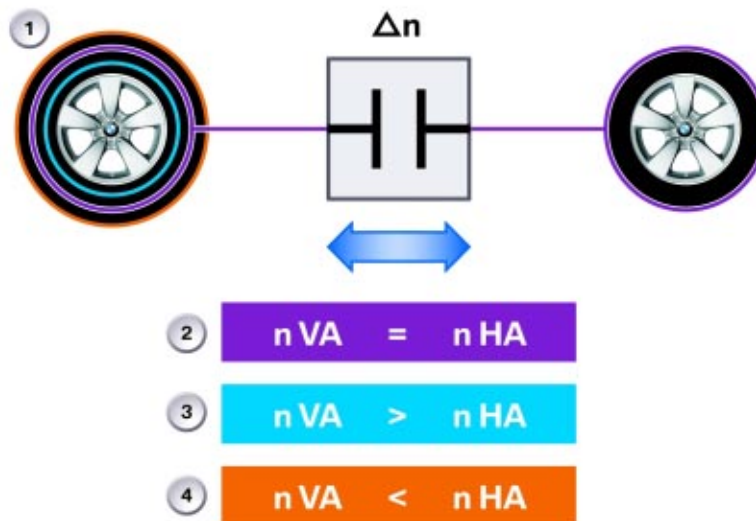

Index	Explanation	Index	Explanation
nVA	Wheel speed at front axle	2	Identical rolling circumference on both axles
nHA	Wheel speed at rear axle	3	Front axle circumference less than rear axle
1	Different rolling circumferences on front axle	4	Rear axle circumference less than front axle

The tire circumference can fluctuate up to 1% or more as a result of mixed tires or wear. The tire tolerance logic decides depending on the driver's command and driving situation whether the slip is to occur in the transfer case clutch or at the contact area between tire and road.

If the slip is permitted in the transfer case clutch, the locking pressure set by the pre-control is reduced in order to keep the work loss low. In the driving dynamic control situation, the clutch is locked slightly more than normal, the four wheel drive is always guaranteed when required.

For maximum xDrive performance, tires (and wheels) of the same diameter should be installed on the vehicle.

---

## ■ Pilot Control

The pilot control algorithm reflects the driver's choice and calculates the necessary lock-up torque as a function of:

- accelerator pedal value,
- engine torque,
- engine speed,
- vehicle speed,
- gear and
- steering angle

while taking into account the maximum load on the clutch, transfer case and axle drive.

The clutch is operated with minimum slip during normal vehicle operation, making available permanent all-wheel drive with a drive torque distribution of 40 % at the front axle and 60 % at the rear axle.

Even in the case of greatly differing frictional values at the front and rear axle, e.g. when the rear axle is on a sheet of ice, the pilot control ensures extremely rapid system response as illustrated in the graphic below.

In addition, as opposed to a transfer case with fixed gear ratio (open longitudinal differential), with xDrive no brake intervention is required at the rear axle in this case as no slip can occur.

In the open longitudinal differential system, the brake is applied on detecting slip at the rear axle. Consequently, 62% of the drive torque is applied at the two rear brake discs so that only 38% of the drive force is available at the front axle for the purpose of driving off the sheet of ice. This takes significantly less time (approx. one/tenth of a second).



“Open” Transfer Case

vs.

xDrive

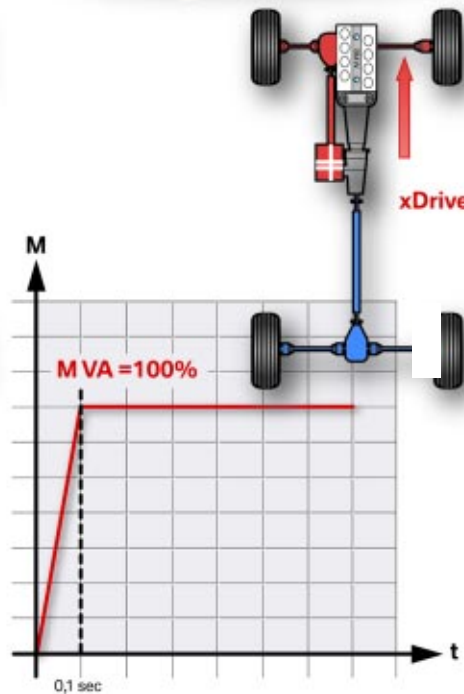
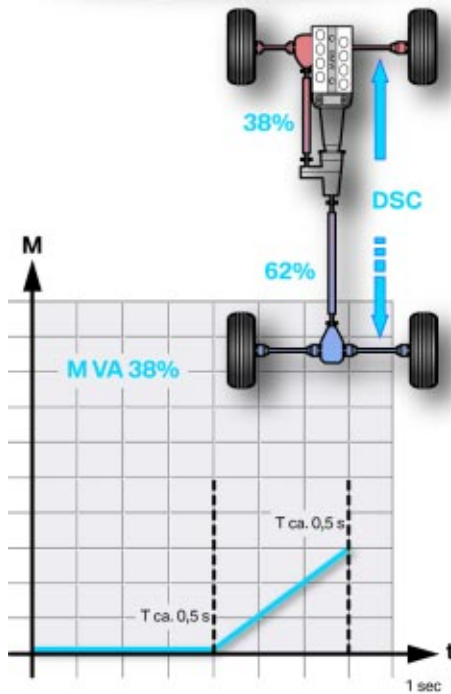

Index	Explanation
M	Driving Torque
M VA	Driving torque on front axle
t	Time

### ■ Traction Control / Driving Dynamics Control

Traction control monitors the slip conditions on the front and rear axles. The wheel speeds, yaw rate and transversal acceleration serve as the input signals.

The function of traction control/driving dynamics control is to achieve optimum traction and to keep the vehicle stable.

As seen in the following graphic, in the event of an oversteer tendency, the transfer case clutch is completely engaged and the maximum supportable driving torque on the front axle is transmitted. This helps to "pull" the front of the vehicle until stability is achieved.

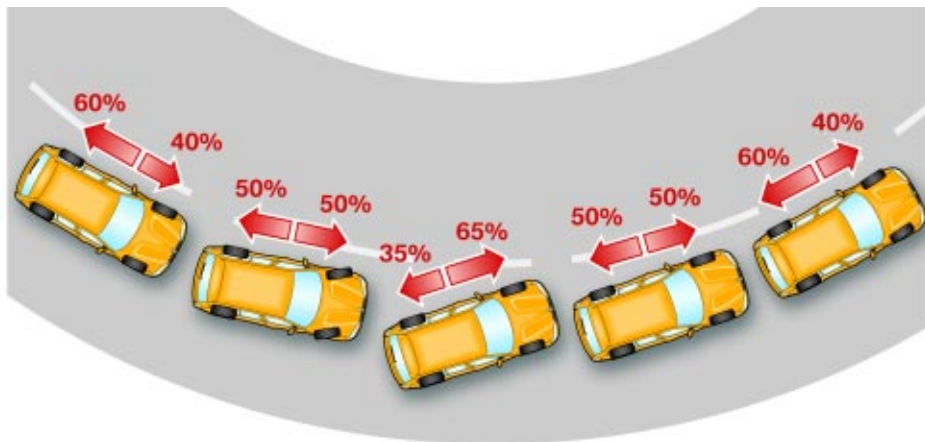

In the event of an understeer tendency, the clutch can be fully disengaged if necessary. In this example, the front axle is separated from the drivetrain and the driving torque can only be transmitted to the rear axle. This helps to "push" the rear of the vehicle until stability is achieved.

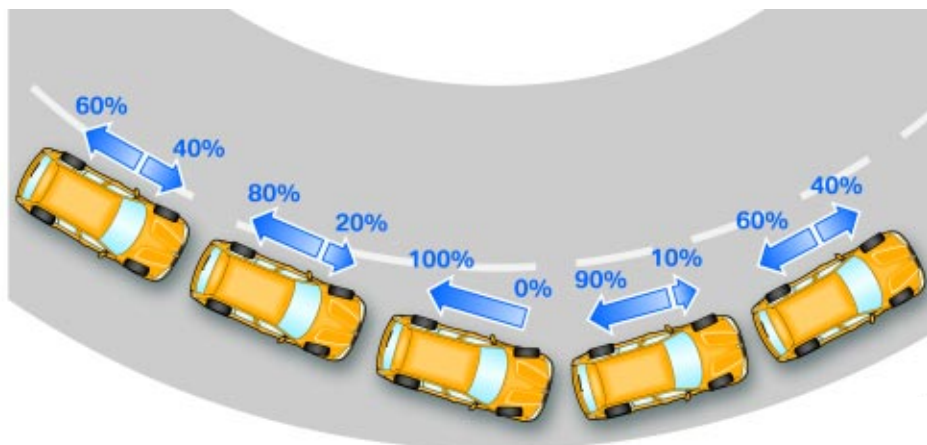

---

### ■ Limp Home Operation

In order to maintain the four wheel drive function for as long as possible even in the event of important sensor signal failures or failure of the DSC control unit, a limp home control is integrated in the transfer case control unit. This control operates in redundancy to the transfer case clutch control in the DSC control unit. The limp home control contains only two control functions, pre-control and traction-slip control.

The wheel speed signals are very important to traction/slip control. Engine signals, steering angle and yaw are used predominantly for pre-control. If individual sensor signals fail, substitute values are calculated and the relevant functions operated with extended control thresholds.

This strategy is continued until useful four wheel drive control is no longer possible. In this event, the driver is alerted by the DSC/xDrive lamp coming on in the instrument cluster and also by an acoustic warning signal (gong).

Faulted wheel speed signals on the rear axle are calculated by driving or engine speed (remember, the rear wheels are always driven). If the front wheel speed signals fail, the values of the rear axle are adopted. Wheel speeds also substitute for a faulty steering angle signal.

**Note: On a vehicle equipped with an automatic transmission, when driving onto brake analyzers, move the selector lever to the “N” position . On a vehicle equipped with a manual transmission, do not press the accelerator pedal once on the brake analyzer. This keeps the transfer case clutch open and the vehicle cannot be pulled off the analyzer.**

---

## Dynamic Stability Control

DXC8+ offers several new features from April 2005 production vehicles. They are:

- ASC-X / ADB-X
- Hill descent control HDC
- Dry braking
- Brake standby
- Automatic soft stop
- Fading assistance
- Drive-off assistant
- Trailer stabilization control

### ■ ASC-X / ADB-X

Unlike regular road vehicles, SAVs are also meant to demonstrate satisfactory handling characteristics and appropriate traction on unconventional roads. In order to provide optimum propulsion with sufficient cornering stability on both normal roads and other road surfaces, Automatic Stability Control X (ASC-X) contains a detection function to distinguish between them.

When off-road terrain is detected, wheel slip threshold is increased to provide sufficient traction force with the increased levels of traction loss.

ASC-X is supplemented by the Automatic Differential Brake (ADB-X) function, which applies the brakes to the wheels per axle, for side to side torque transfer. For example, when a wheel is spinning on one side (up to the slip setpoint), the brakes are applied to that wheel and the driving torque is transferred through the axle differential to the wheel with the higher traction. This provides superb capabilities when there are diagonal traction losses (ie. left front/right rear).

ADB-X remains active when DSC is deactivated. Furthermore, ADB-X can develop full capability because the engine power is not reduced, even during extreme four wheel drive operation. Only that wheel which has a low traction receives the brake application.

The brake disc can overheat with excessive ADB-X intervention with DSC deactivated. In this situation, the operation is discontinued at a disc temperature of approx. 700 °C and is resumed when this temperature drops below approx. 400 °C. This is a calculation performed by the DSC control unit based on brake application time, pressure, wheel speed, etc.

### ■ Hill Decent Control (HDC)

As on previous all wheel drive vehicles in the BMW line, the E61 all-wheel drive also features the hill descent control facility for safe vehicle operation on steep downhill inclines. The HDC stabilizes the vehicle and prevents the wheels locking. The DXC8+ module controls the build-up of braking pressure at all four wheels so that the vehicle drives downhill at a speed of approx. 7.5 mph (12 km/h).

The HDC function is activated in the central information display via the menu:

Settings => Vehicle settings => HDC

The HDC ON function can be activated by setting a tick in the menu and deactivated by removing the tick.

Furthermore, the HDC ON/OFF function can be selected with one of the two free buttons (asterisk, hash) in the steering wheel button menu.



Menu HDC ON / Active

### ■ Dry Braking

The water spray produced in wet conditions coats the brake discs with a water film, causing delayed response of the brakes. In connection with previous systems it was therefore recommended to operate the brakes from time to time.

The dry braking function is dependent on the position of the wiper switch and therefore on the signal of the rain/lights sensor. The brake discs are kept dry by lightly applying the brake pads cyclically as required, this achieving improved braking response in wet conditions.

While doing so, the pressure in the brake system is increased by approx. 1 bar and the brake pads are applied for approx. 1.5 seconds.

Dry braking takes place under following conditions:

- Driving speed > 70 km/h
- Continuous wipe operation in stage 1 or 2

The repeat interval depends on the wiper stage:

- Continuous wipe stage 1 - 200 s
- Continuous wipe stage 2 - 120 s
- Generally 90 s as from 09/2005

This applies only when the driver himself does not apply the brake during this time.

The driver notices no deceleration or noise.

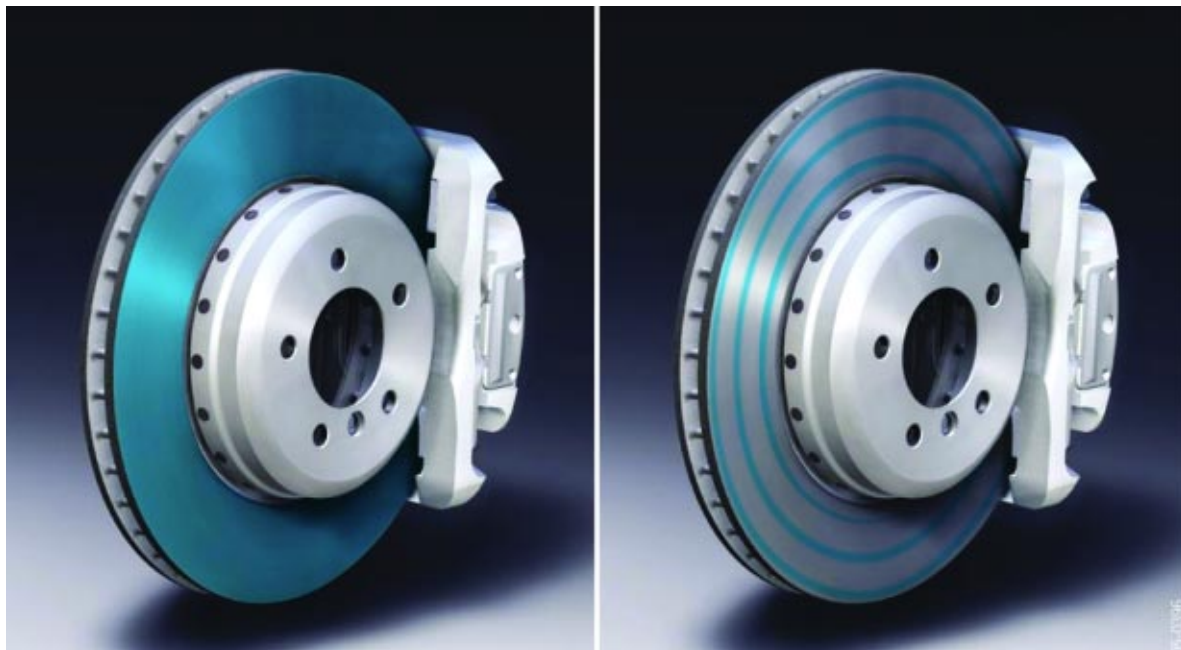

Left disc with water film before dry braking    Right brake disc after dry braking

### ■ Brake Standby

Quick release of the accelerator pedal causes the brake pads to be applied against the brake disc thus reducing the stopping distance (by approx.. 30 cm/100 km/h) during emergency braking. The DSC module builds up slight brake pressure (approx. 2.5 bar) temporarily (approx. 0.5 seconds) in order to eliminate the clearance between the brake pad and brake disc by applying the brake pads.

The brake standby function is activated under following conditions:

- Driving speed > 70 km/h
- Minimum time between brake application 8 s
- The brake standby function is not activated in connection with sudden acceleration (sports driving style).

The DME/DDE control unit makes available the signal indicating quick release of the accelerator pedal via the PT-CAN.

The sensitive driver may perceive a slightly harder brake pedal. No delay or noise is discernible for the driver.

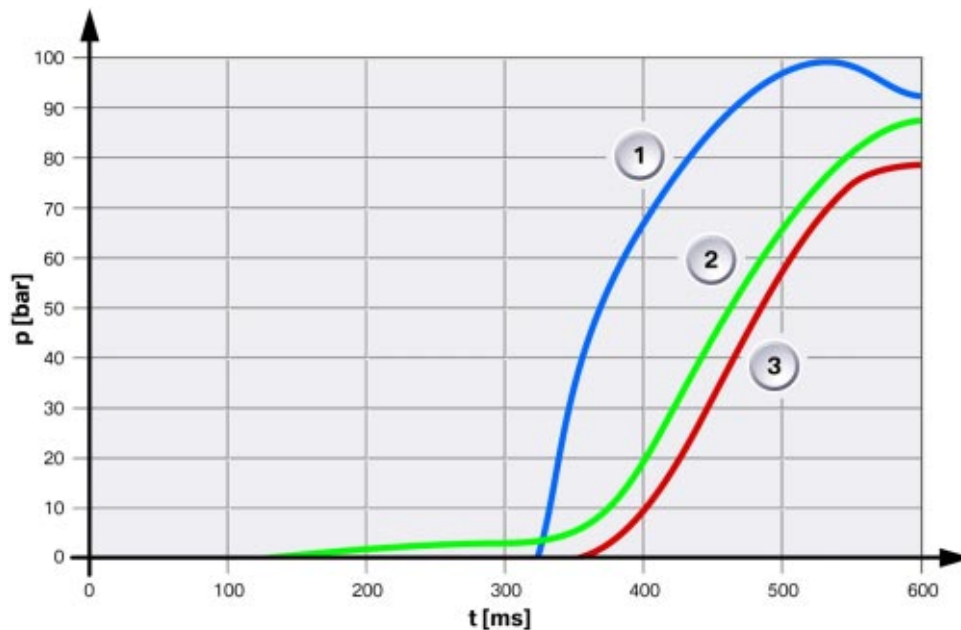

Index	Explanation
P	Braking pressure in Bar
T	Time in milliseconds
1	Pilot pressure applied by driver
2	Braking pressure progression with brake standby
3	Braking pressure progression without brake standby

### ■ Automatic Soft Stop

Due to the transition from sliding friction to static friction on the brake disc, a stopping jolt occurs when braking to a standstill where the occupants perceive an increased feeling of deceleration.

When braking lightly (< 25 bar) at constant pressure to bring the vehicle to a halt, the soft stop function automatically reduces the braking pressure at the rear axle just before the vehicle comes to a stop. This consequently reduces the positive acceleration peak perceived by the occupants by approx. 50% while extending the action time.

The speed and standstill status are recognized by way of the wheel speed sensors.

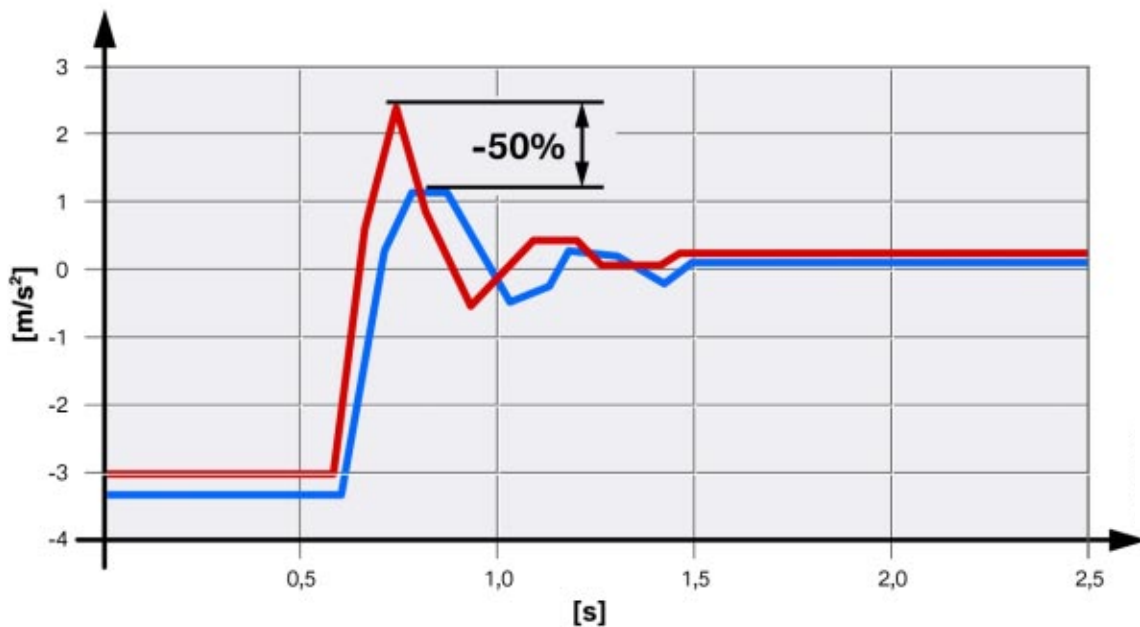

Index	Explanation
$m/s^2$	Deceleration
s	Time in seconds
Red	Deceleration without soft stop
Blue	Deceleration with soft stop
-50%	Reduction of occupant deceleration

**Note: This function is inactive at medium to high deceleration or in the event of ABS control in order not to lengthen the stopping distance.**



---

### ■ Fading Compensation

High temperatures ( $> 550^{\circ}\text{C}$ ) can occur at the brake discs when driving downhill over long periods or as the result of extreme multiple braking operations ( $> 80$  bar). These high temperatures cause a change in the coefficient of friction of the brake pads resulting in the braking effect diminishing (fading).

For this purpose, the temperature of the brake disc is calculated by means of a temperature model contained in the DXC8+ software. The braking pressure applied by the driver is measured by the delivery pressure sensor and compared with the current vehicle deceleration (target/actual value).

When the braking effect diminishes, the fading compensation provides assistance for the driver in that pressure is additionally built up by the DSC module.



Brake Disc with Fading

#### ■ Drive-off Assistant

When negotiating uphill gradients, the drive-off assistant holds the vehicle for a short time (approx. 1.5 s) after releasing the brake so that the vehicle drives off comfortably without the need to use the handbrake. The braking pressure required by the driver to hold the vehicle is maintained automatically in the system.

When driving off, the braking pressure is not reduced before the torque is sufficient for the vehicle to drive off. The holding pressure in the brake system (10 to max. 70 bar) is dependent on the uphill gradient.

Uphill gradients are detected by the DSC sensor with the aid of a longitudinal acceleration sensor.

The function is active both when driving forwards (transmission in Drive) and when reversing (transmission in Reverse) on uphill gradients (up to 50 %).



Drive-off Assistant Function

NOTES

PAGE

---

## Service Information

### **Safety Notice!!!**

On a vehicle equipped with an automatic transmission, when driving onto brake analyzers, move the selector lever to the "N" position. On a vehicle equipped with a manual transmission, do not release the clutch pedal once on the brake analyzer.

This keeps the transfer case clutch open and the vehicle cannot be pulled off the analyzer.

### **Towing**

Use only a flatbed carrier!

### **Oil, Transfer Case, and Clutch Monitoring**

#### ■ Oil

All xDrive transfer cases use Shell Gear oil part number 83 22 0 306 816.

There is no scheduled service for the transfer case oil. Oil Monitoring is performed by the VTG control module to determine when a service (change) is due. The VTG calculates transfer case and clutch wear based on the amount of slip, engagement pressure (torque), speed and mileage.

This calculation accounts for:

- normal "dry" road driving (Integrator 1)
- "adverse" road driving (Integrator 2)
- "other" road extreme driving (Integrator 3)

Depending on individual vehicle use - driving styles and driving conditions, the transfer case oil service interval will vary.

When a service is due, this will be indicated by a Fault Code and additional details are available using the DISplus/ GT1. Service functions provide directions on changing the transfer case oil and updating the VTG control module with the necessary reset and adaption procedure. This is extremely important for CBS.

#### ■ Transfer Case and Clutch

The transfer case and clutch have separate monitoring characteristics. These values are stored as adaptive values in the VGSG control unit and must be transferred to a new control unit if replaced.

The value for both can be obtained using the diagnostic software under:

Control Unit Functions => VTG => Diagnosis requests => Transmission

Control Unit Functions => VTG => Diagnosis requests => Clutch

## Diagnosis

Diagnosis is available for fault repairs and service procedures using the DISplus/GT1.

The test plan for the VGSG contains valuable information on:

- Replacing control unit
- Replacing transfer case
- Transferring adaptation values
  - Automatic
  - Manual
- Reading out adaptation values

## Programming (flashing)

Both the transfer case control unit (VTG) and the DSC control unit are programmable and the new control unit(s) must be programmed when replaced. The wear values stored in the VTG control module (to be replaced) must be transferred to the replacement VTG.

















## Warning Indicator Lamps

The warning indicator lamps for the xDrive / DSC are found in the instrument cluster as shown on the bottom of this page.





















The warning indicator lamps and acoustic signals (gong) are assigned to the xDrive / DSC system states of malfunction described on the next two pages.

## Check Control Messages Relating to xDrive / DXC8+

Fixed indicator lamp	Variable indicator lamp	Check control message	Information in central information display
		DSC disabled!	You have disabled DSC. Restricted vehicle stability while accelerating and cornering.
		DTC enabled, DSC restricted!	DTC enabled. Dynamic traction control DTC increases forward propulsion on unpaved surfaces, however, it decreases vehicle stability.
		DSC failed! Drive with moderation	DBC failed. No additional braking assistance from DBC in emergency braking situations. Drive with moderation. Have checked by your BMW dealer as soon as possible.
		DSC failed! Drive with moderation	DSC failed. Restricted vehicle stability while accelerating and cornering. Drive with moderation. Have checked by your BMW dealer as soon as possible.
		Control systems! Drive with moderation	Brake and vehicle control systems failed. Reduced braking and vehicle stability. Avoid abrupt braking where possible. Have checked by nearest BMW dealer.
		Control systems! Drive with moderation	Brake and vehicle control systems failed. Drive with moderation, avoid abrupt braking where possible. Have checked by nearest BMW dealer.
		Brake pads! Replace	The brake pads are worn. Have replaced by nearest BMW dealer.
		Brake fluid! Stop cautiously	Brake fluid level too low. Reduced braking efficiency. Stop cautiously. Contact nearest BMW dealer.
		Brakes too hot! Allow to cool down	Brakes too hot Critical temperature as a result of permanent heavy load. Danger - reduced braking efficiency. Allow brakes to cool down. Stop if necessary.

Check Control Messages Relating to xDrive / DXC8+ (cont'd)

Fixed indicator lamp	Variable indicator lamp	Check control message	Information in central information display
		Brakes overheated! Allow to cool down	Brakes overheated Critical temperature exceeded. Braking efficiency no longer guaranteed. Stop at the next opportunity and allow to cool down substantially.
		4x4 system and DSC failed!	4x4 system and DSC failed! Vehicle stability restricted. Drive with moderation. Have checked by your BMW dealer as soon as possible.
		4x4 system defective! Drive with moderation	4x4 system defective Vehicle stability restricted. Drive with moderation. Have checked by your BMW dealer as soon as possible.
		4x4 system, DSC and ABS failed!	4x4 system, DSC and ABS failed! Vehicle stability restricted. Drive with moderation. Have checked by your BMW dealer as soon as possible.
		4x4 System, DSC, ABS and emergency EBV failed!	4x4 System, DSC, ABS and emergency EBV failed! Vehicle stability restricted. Drive with moderation. Have checked immediately by your BMW dealer.
		HDC enabled!	
		HDC disabled!	HDC disabled. Hill descent control HDC is disabled at speed above 60 km/h (37 mph). System can be re-enabled at speed below 35 km/h (22 mph).
		No HDC control! Drive slower	HDC not possible! Control range ends at 35 km/h (22 mph). To use HDC, reduce speed accordingly.
		HDC currently not available!	HDC not available. Automatic brake intervention interrupted for safety reasons as brakes are overheated. Shift down and drive carefully in order to reduce temperature.
		Drive-off assistant inactive!	Drive-off assistant inactive Caution, vehicle can roll back! Have checked by your BMW dealer at next opportunity.
		Electronics fault! Stop cautiously	Central vehicle electronics failed. Continued journey not possible. Contact nearest BMW dealer.



# Body

The E60 and the E61 are identical in body structure and design from the front bumper to the B-pillar.

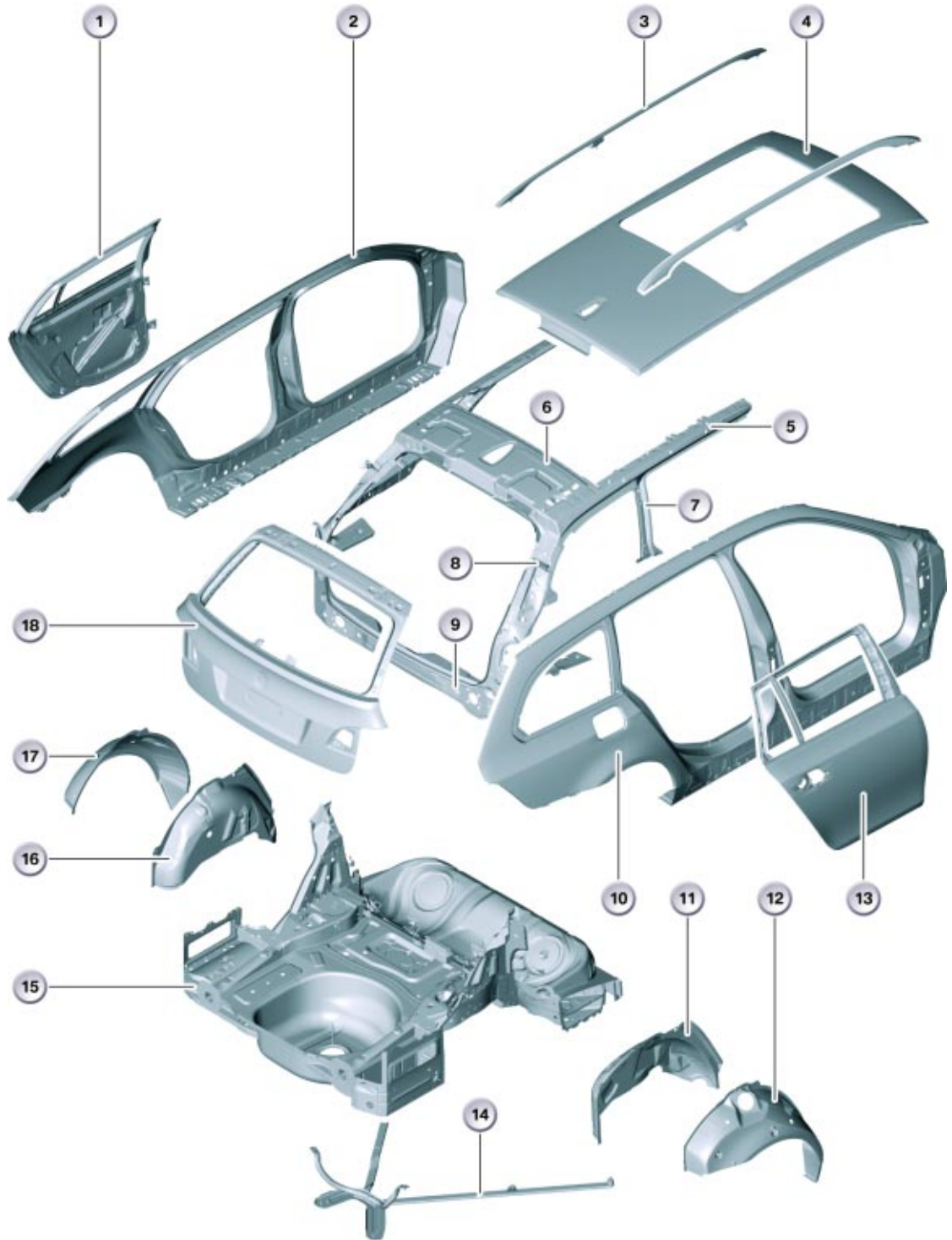

## E61 Body Modifications



### Legend for E61 Body Modifications

Index	Explanation	Index	Explanation
1	Rear Left Door	10	Side Frame, Right
2	Side Frame, Left	11	Inner Rear Right Wheel Arch
3	Roof Railing	12	Outer Rear Right Wheel Arch
4	Roof Outer Skin Panel	13	Rear Right Door
5	Roof Frame Reinforcement, Right	14	V-Shaped Tension Strut
6	Rear Window Frame	15	Floor Pan, Rear
7	Right C-Pillar	16	Inner Rear Left Wheel Arch
8	Right D-Pillar	17	Outer Rear Left Wheel Arch
9	Cross Member, Rear paneling	18	Rear Hatch

### E61 body features:

- The rear doors have been redesigned for the Touring.
- The rear hatch was designed similar to the E39 Touring with a separately opening rear window.
- The front/rear floor pans are the same as on the E60 but the rear floor pans are a new design.
- The outer half of the rear wheel arches is the same as on the E60 while the inner half is new.
- The side frames and pillars are the same as on the E60 in the front area and new at the rear.
- The roof frame is the same as on the E60 in the front area but new at the rear. The roof frame features additional reinforcement in the area of the C-pillar.
- The roof outer skin panel is new.
- To increase the body rigidity, a V-shaped tension strut is fitted on the underbody on vehicles equipped with the panoramic glass sunroof (SA 402 All US Models).

## Rear Doors

The rear doors on the E61 are the same as the E60 up to the level of the shoulder but with variations specific to the Touring:

- Door inner panel and closing plate are new
- Modified reinforcement of window frame - C-pillar

The window system at the rear doors are the same as on the E60 but with the following variations specific to the Touring. New features are:

- Inner window frame cover
- Outer window frame
- Window guide rail
- Outer weatherstrip
- Windowpanes and their surround
- Door seals

## Panoramic Glass Sunroof

The panorama glass sunroof in the E61 is the same as the panorama glass sunroof on the E53 and the E83. The functional principle is also the same.

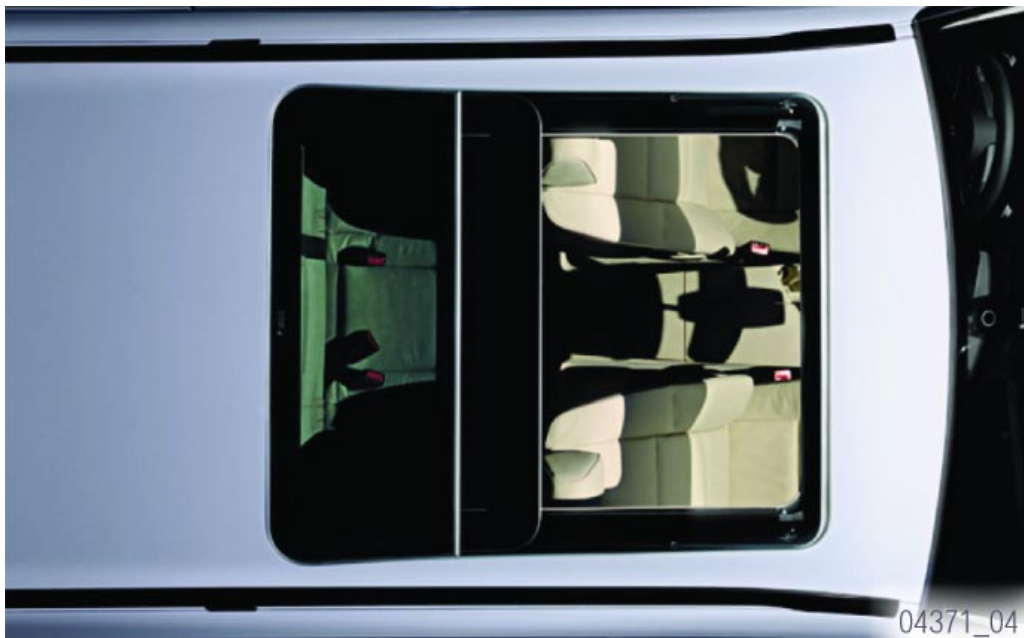

E61 Panorama Glass Sunroof

## System Components

The panorama glass sunroof assembly consists of the following components:

- Panorama Glass Sunroof control module, MDS
- 2 Drive Motors
- 2 Part floating headliner
- 2 Glass covers
- Wind deflector

### Multi Drive Sunroof Control Module

The MDS contains the following components:

- Control Electronics
- K-CAN Interface
- Drive motor Relay
- Hall Sensor Power Supply

The Multi Drive Sunroof MDS controls and monitors the electric motors and therefore the movement of the panorama glass sunroof.

The MDS is installed on the carrier behind the glove compartment.

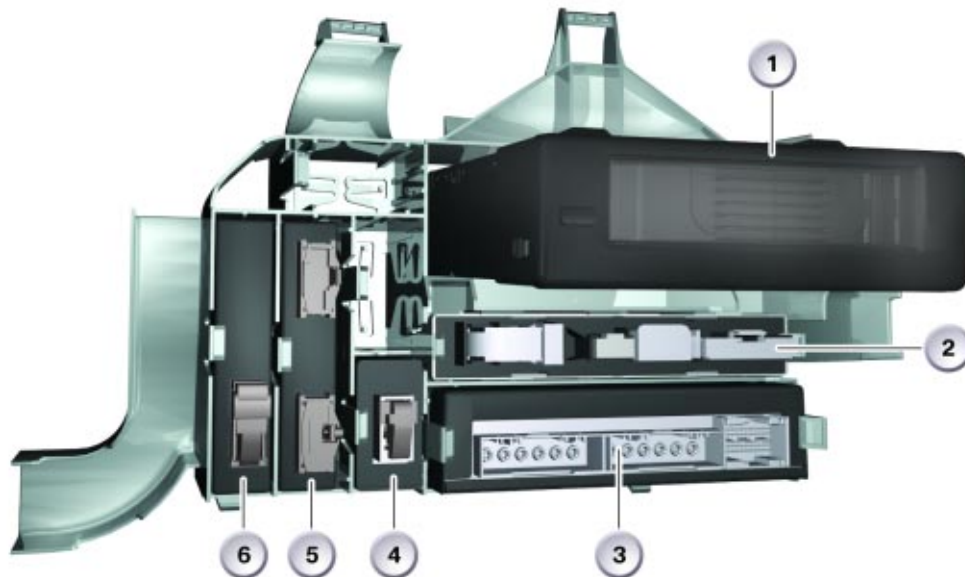

Control units in the carrier behind the glove compartment

Index	Explanation	Index	Explanation
1	CD changer CDC	4	Adaptive headlight AHL
2	Basic body module KBM	5	Multi Drive Sunroof MDS
3	Safety and gateway module SGM	6	Comfort Access (9/2005)

---

### ■ Drive Motors

The system utilizes two DC motor. One motor is used to drive the glass panels and the other is used for the headliner (visor) and wind deflector.

The hall sensors are integrated in the motors to detect motor revolutions. These signals are forwarded to the MDS for analysis.



Drive Motors

### ■ Floating Headliner

The floating headliner consists of two parts controlled by a Bowden Cable.

The headliner is interlocked to the function of the glass roofs. The headliner must be opened before the glass sunroof will open. On closing the glass sunroof must be closed before the headliner can be closed or

Double selecting open or close on the switch will allow the glass panels and the headliner to move at the same time.



---

### ■ Glass Panels

Two glass covers are installed in the panorama sunroof cassette. Six bolts secure the front glass to the frame and four bolts secure the rear glass. Both the front and rear glass panel can tilt, but only the front panel can retract and fully open.

### ■ Power Supply and K-CAN Interface

The MDS acts as the power supply module for both the sunroof motor and the headliner motor. Communication with the rest of the car is through the K-CAN. The MDS receives and transmits K-CAN messages.

### ■ Wind Deflector





The wind deflector is cable operated by the rear (headliner) motor and is regulated by the MDS control module by using the vehicles speed signal.



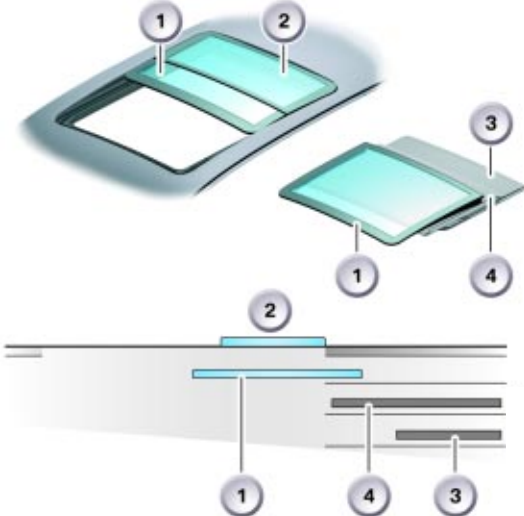

## System Operation

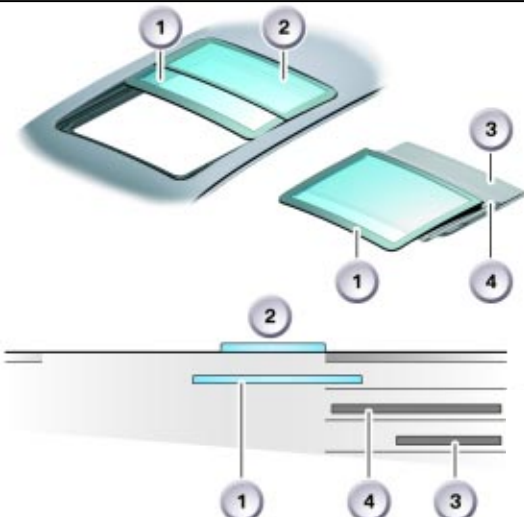

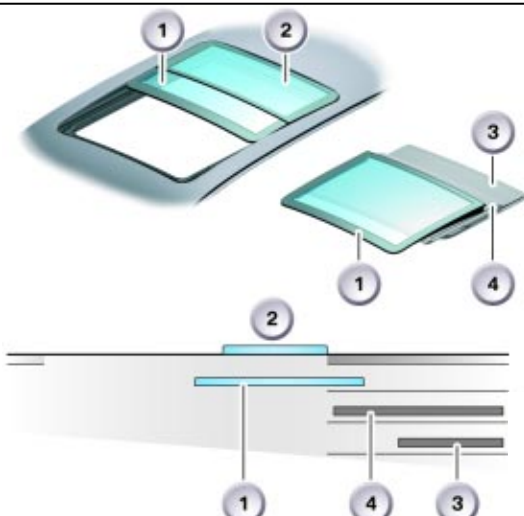

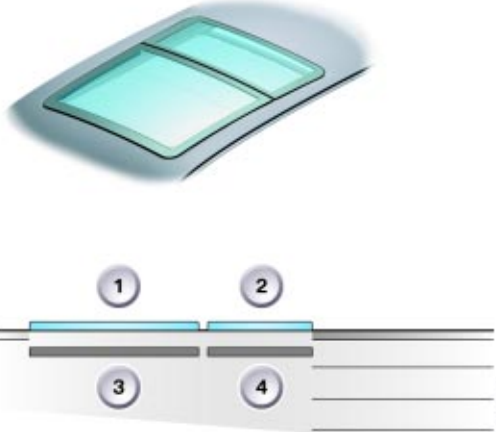
Operation of the panorama sunroof is similar to the conventional slide/tilt sunroof. It functions both as a tilting sunroof and a slide/tilt sunroof. The rear glass only tilts, the front glass slides and tilts. Rear tilt is possible only when the front glass is also tilted. The KBM signals the MDS for convenience opening and closing of the panorama glass sunroof.

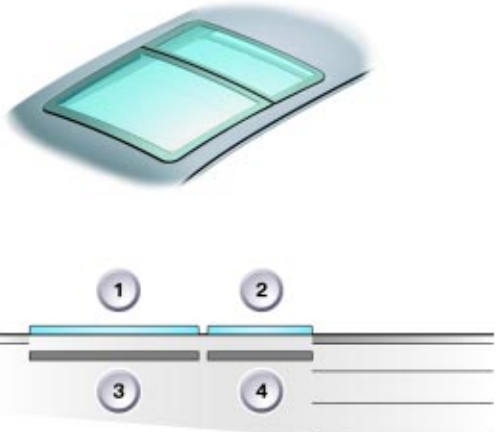
The panorama glass sunroof is operated as follows:

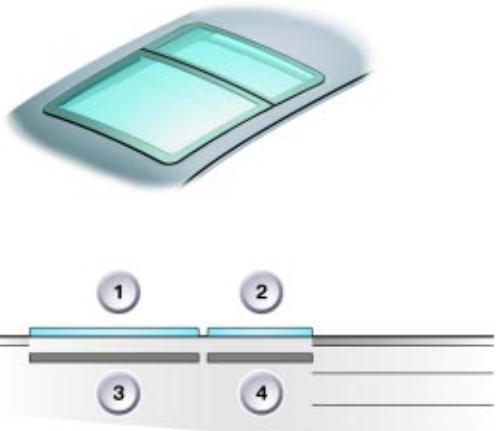
- Headliner and glass sunroof Closed.
- Headliner closed, front and rear glass in tilt position (Headliner goes to vent position).
- Headliner open, sunroof closed.
- Headliner open, sunroof opened manually.
- Headliner open, sunroof opened to comfort position (Via one touch opening).
- Headliner open, sunroof opened fully (Beyond comfort position).

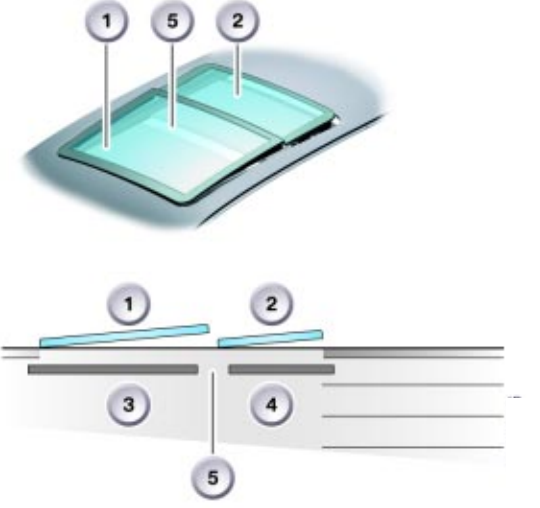
Control Button	Movement	Panorama Glass Sunroof Positions
<p><b>1</b></p>  <p>TE03-3368</p> <p>Manual opening of panorama glass sunroof by sliding button to first detente position</p>	<p>Floating headliner of glass tilt sunroof and slide/tilt sunroof are opened until the control button is released.</p>	
<p><b>2</b></p>  <p>TE03-3369</p> <p>Automatic opening of panorama glass sunroof by sliding the button beyond the pressure point to the second detente position</p>	<p>Panorama glass sunroof is automatically opened to the comfort position.</p>	
<p><b>3</b></p>  <p>TE03-3370</p> <p>Double-click function</p> <p>Automatic opening of panorama glass sunroof by sliding the button twice beyond the pressure point to the second detente position</p>	<p>Panorama glass sunroof is automatically opened to the comfort position.</p>	

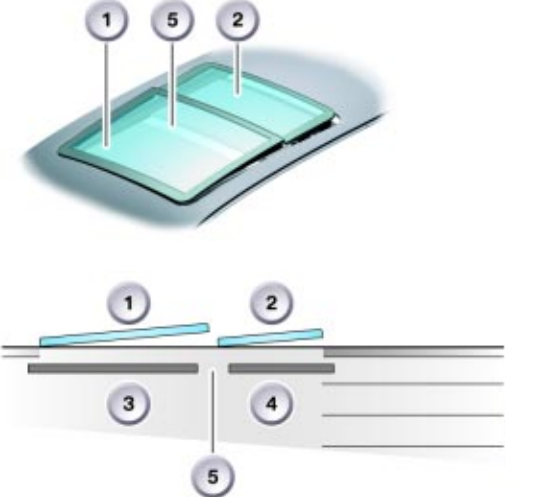
Control Button	Movement	Panorama Glass Sunroof Positions
<p>4</p>  <p>TE03-3371</p> <p>Manual closing of panorama glass sunroof by sliding control button in first detente position</p>	<p>Floating headliner or glass tilt and slide/tilt sunroofs are closed until the control button is released</p>	
<p>5</p>  <p>TE03-3373</p> <p>Automatic closing of panorama glass sunroof by sliding the button beyond the pressure point to the second detente position</p>	<p>Floating headliner or glass tilt sunroof or slide/tilt sunroof are fully closed</p>	
<p>6</p>  <p>TE03-3372</p> <p>Double-click function</p> <p>Automatic closing of panorama glass sunroof by sliding the button twice beyond the pressure point to the second detente position</p>	<p>Floating headliner and glass tilt sunroof or slide/tilt sunroof are fully closed</p>	

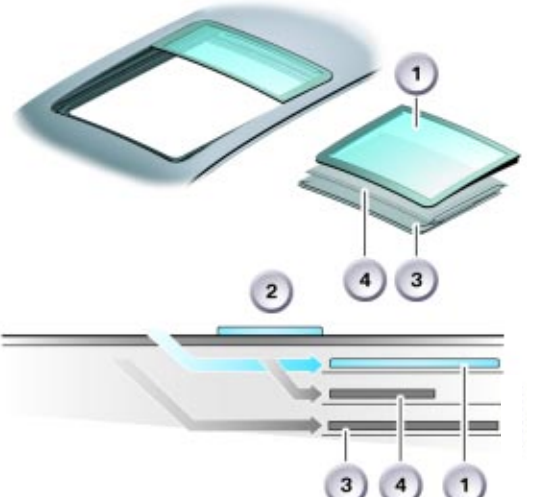
Control Button	Movement	Panorama Glass Sunroof Positions
<p><b>7</b></p>  <p>Manual opening of panorama glass sunroof by pressing control button to first detente position</p>	<p>Panorama glass sunroof is opened to raised position until the control button is released</p>	
<p><b>8</b></p>  <p>Double-click function</p> <p>Automatic opening of panorama glass sunroof by pressing the button beyond the pressure point to the second detente position</p>	<p>Panorama glass sunroof is fully opened to raised position and the floating headliner is moved to the vent position.</p>	
 <p>After opening panorama glass sunroof via one touch, the sunroof may be opened fully (rather than the comfort position) by sliding the control button to the first detente and holding.</p>	<p>Front glass of panorama sunroof will move from comfort position to fully open position.</p>	



## ■ Floating Headliner

### Opening

On opening the front part of the headliner moves over the rear part of the floating headliner. The special feature of the floating headliner is that it can be opened fully without the sunroof being open or tilted.

### Vent Mode

When the panorama glass sunroof is moved into the tilt position, the floating headliner is moved into the vent position.

The vent position reduces the suction effect at high road speeds.



Vent Mode

## ■ Wind Deflector

The wind deflector is regulated according to road speed. When the sunroof is opened the wind deflector goes from the down position to the intermediate position. It remains in this position until road speed is seen by the MDS. Then the wind deflector is placed in the extended position. At roads speeds greater than 140km/h (84mph) it is retracted back to the intermediate position. If the road speed drops below 100km/h (62 mph), the wind deflector is again raised.



Down Position



Intermediate Position



Extended Position

---

## Service

### ■ Initialization

Initialization must be performed on the panorama glass sunroof anytime the MDS loses positioning of the glass panels or the headliner or if the any component of the sunroof assembly is replaced.

The control button is pressed and held in the position to tilt the sunroof. Initialization begins approximately 15 seconds after pressing the button. The initialization process may take over 2 minutes to perform.

**Note: The control button MUST be held in the tilt position during the entire initialization process. Failure to hold the button will result in improper initialization.**

During initialization the panorama sunroof will operate as follows:

- Both sunroof panels enter tilt position(Headliners enter Vent Mode)
- Both Headliners open
- Both sunroof panels lower
- The front sunroof panel opens then closes
- Both Headliners close

### ■ Anti-Trapping Protection

Both the covers and the floating headliners are fitted with anti-trap protection. If the MDS detects something in the path, the appropriate motor is stopped and activated in the reverse direction.

## Service Notes

The motors may be replaced individually. An initialization procedure is required after replacing one or both of the motors

The MDS control unit may be replaced separately. It must although be coded before initializing.

## Interior

The interior trim and upholstery of the E61 has largely been adopted from the E60. Due to the body changes, the interior trim and upholstery from the B-pillar has been adapted to the Touring.

From April 2005 production the interior of the vehicle will be equipped with upgraded soft paint surfaces and air conditioning control knobs in "ruthenium finish".



Index	Explanation
1	Fresh air grill in "ruthenium finish"
2	Chrome finish IHKA Rotary Knobs

## Luggage Compartment

The load area is flat with the rear seat backrests folded down. 4 lashing eyes are fitted as standard on the floor of the luggage compartment.

The vehicle tool kit is located in a utility box on the left-hand frame side member.

The lockable luggage compartment floor can be raised and with the aid of gas spring struts (similar to the hood) remains in the required position until it is pressed down again.

A variable storage area for small parts is provided under the luggage compartment floor. Located below this is the spare wheel or a further storage area (35 liters) if the vehicle is equipped with run-flat tires.



Luggage Compartment, Floor Partly Raised

Luggage Compartment Trim Panels

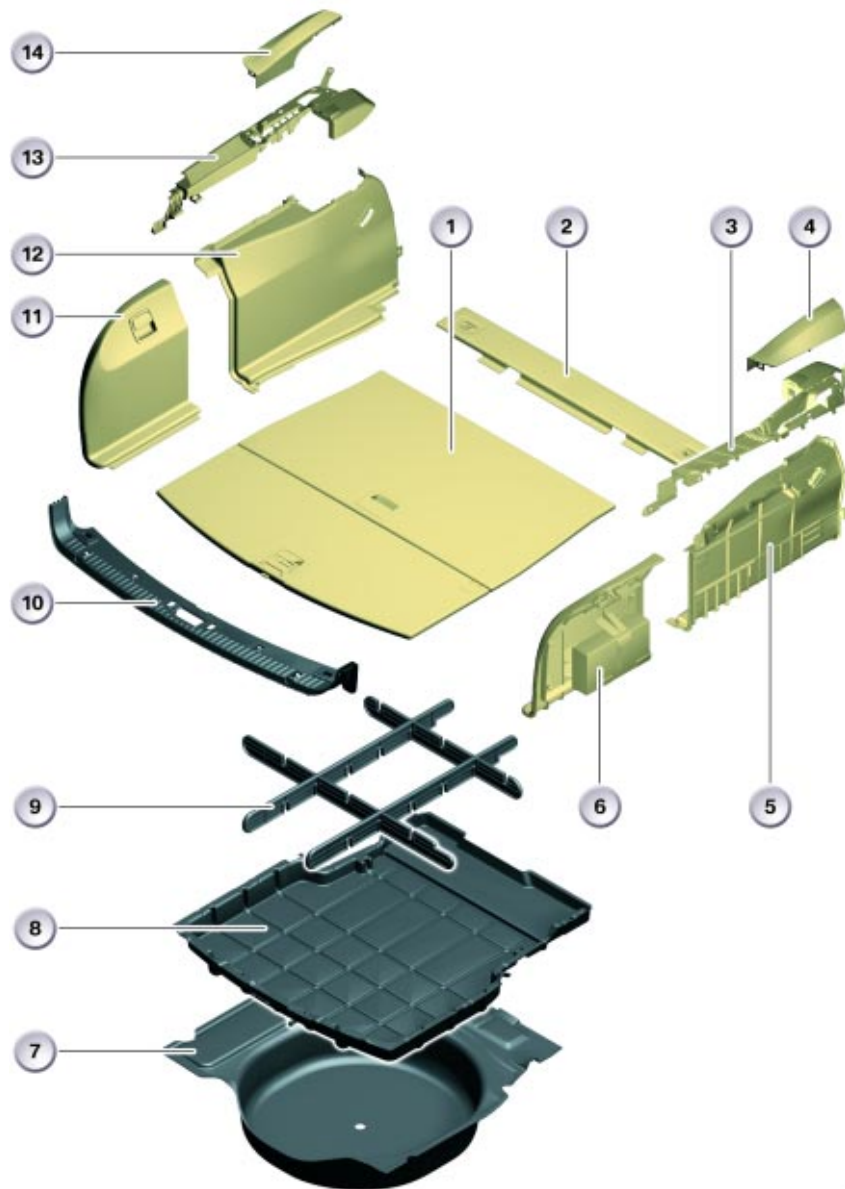

Index	Explanation	Index	Explanation
1	Luggage compartment floor	8	Storage tray, luggage compartment floor
2	Cross member cover	9	Partitions
3	Shoulder trim panel, right	10	Luggage compartment sill cover
4	Rear right cover	11	Luggage compartment flap, left
5	Luggage compartment panel, right	12	Luggage compartment trim panel, left
6	Luggage compartment flap, right	13	Shoulder trim panel, left
7	Trim panel for luggage compartment well	14	Rear left cover

## Luggage Compartment Roller Cover

The partition net is integrated in the standard luggage compartment roller cover (similar to E39/2). The luggage compartment roller cover is attached at the D-pillars. It can be removed and, with the rear seat backrest folded down, attached to this backrest. Depending on where the roller cover is fastened, the partition net can be attached at the support elements in the headliner (behind B-pillar or C-pillar).

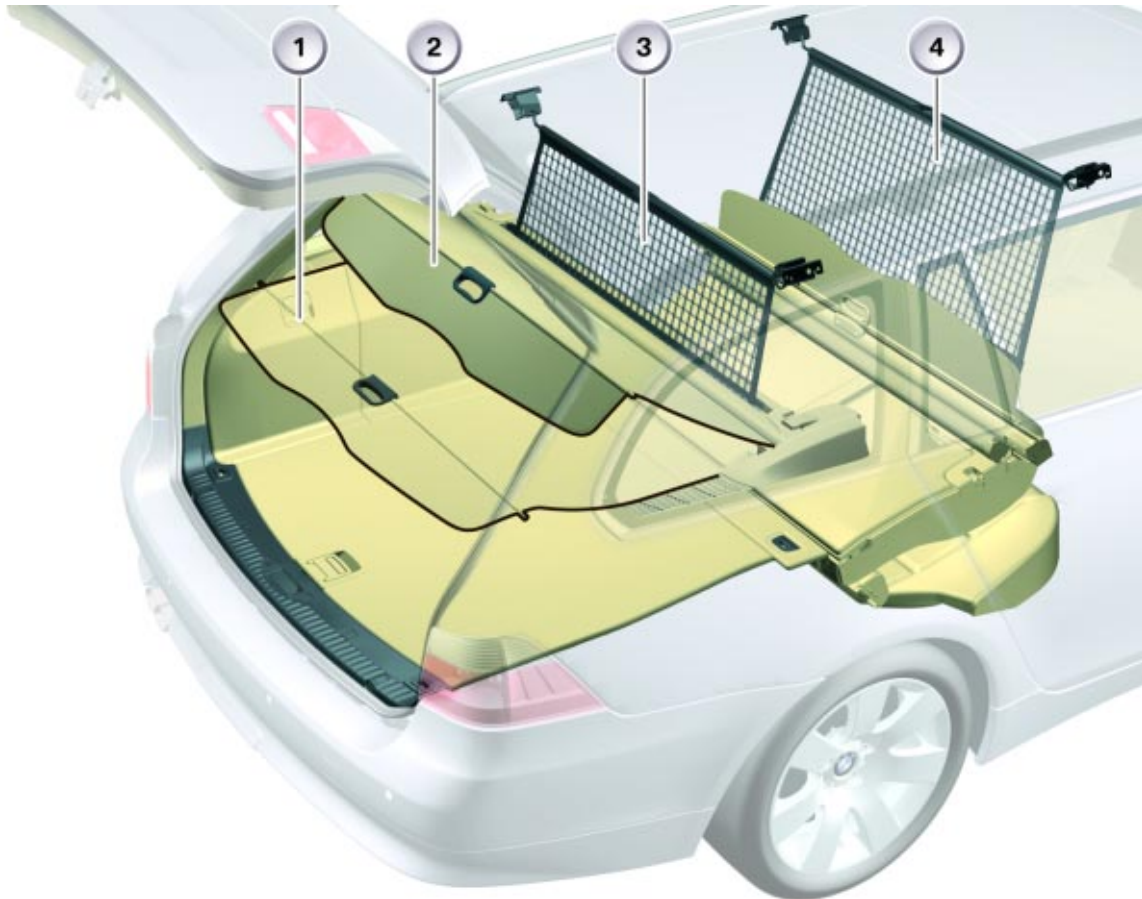

### Fastening points for luggage compartment roller cover/net partition

Index	Explanation
1	Luggage compartment roller cover, bottom position
2	Luggage compartment roller cover, top position
3	Net partition fastening point at C-pillars
4	Net partition fastening point at B-pillars

### ■ Luggage Compartment Roller Cover Lock Mechanism

The load area cover motors in the D-pillars are driven by the KBM for approx. 1.5 seconds when the rear hatch or rear window is opened.

The release pins are pulled back via a gear drive and the luggage compartment roller cover attached to the D-pillars is released. The roller cover slide upwards in the guide, due to the return force of spring loaded roller cover. This makes it possible to conveniently load and unload the luggage compartment.

The roller cover does not retract automatically. The cover has to be pushed back until automatically locked at the lock pin.

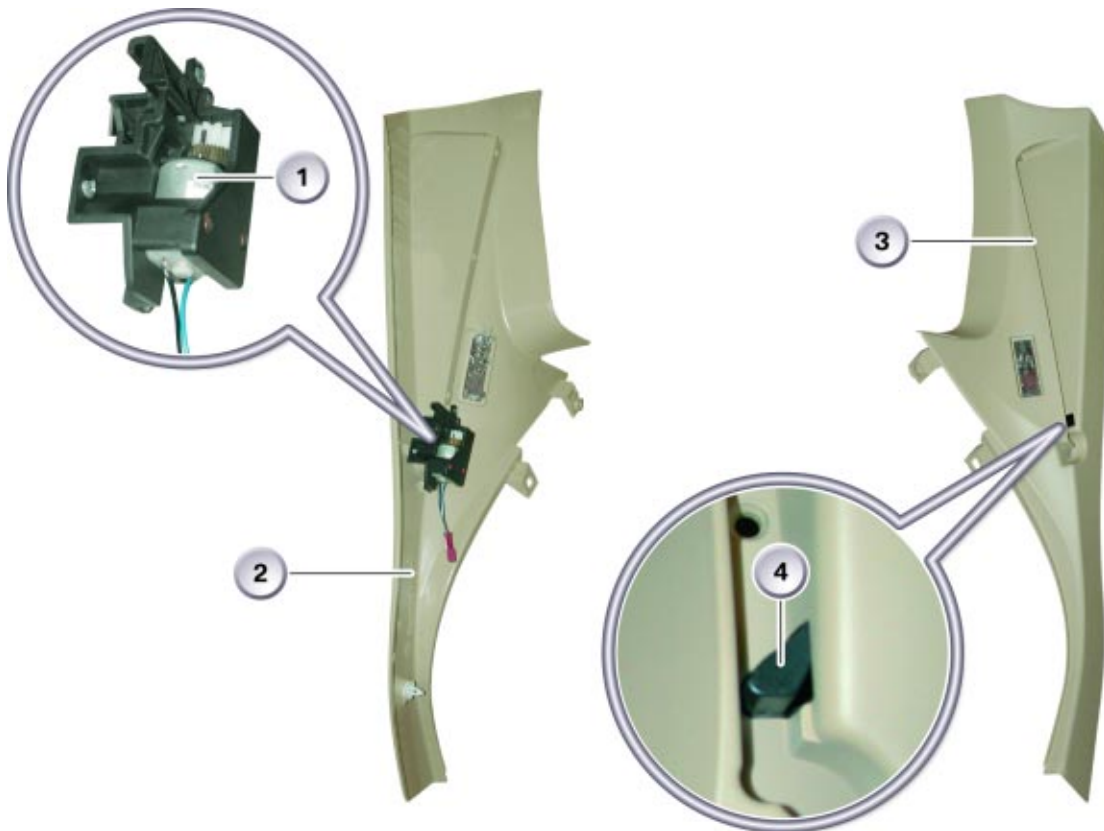

Lock mechanism of luggage compartment roller cover

Index	Explanation
1	Load area cover motors
2	D-pillar trim panel
3	Guide
4	Locking pin



## Headliner

The headliner has been modified for the panoramic sunroof and the extended length of the E61 rear end.

The C-pillar cover is divided in two sections to accommodate the head airbag AITS II.

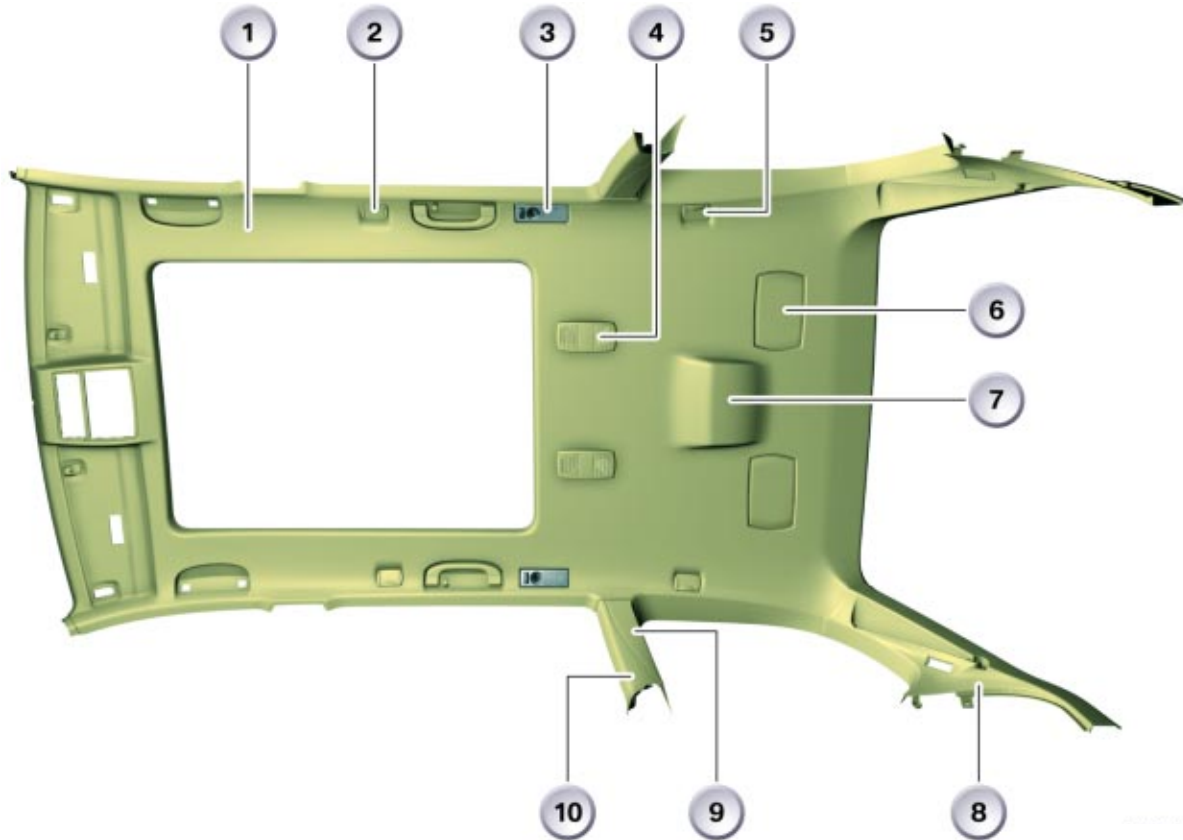

## Headliner

Index	Explanation	Index	Explanation
1	Headliner	6	Speaker cover
2	Net partition attachment point, front	7	DWA (behind headliner)
3	Rear compartment light	8	D-pillar cover
4	Cover for ultrasonic interior movement detector	9	C-pillar cover, rear
5	Net partition attachment point, front	10	C-pillar cover, front



---

## Seats

### ■ Front Seats

The front seats in the E61 are identical to those of the E60.

### ■ Rear Seats

The rear seats are always offered with the fold down capabilities as standard. The seat backrest can be folded down completely or at a 60:40 ratio. The wider part of the backrest is located behind the driver's seat. The ski bag and the center three-point seat belt are integrated in the wider part of the seat backrest.

Seat heating for the rear seats is available as an option only in conjunction with a cold weather package and leather seats. The ski bag can be completely removed to facilitate easy cleaning.

The rear headrests (also the center headrest) can be adjusted manually and are identical to those of the E60. The center headrest as well as two cup holders and an oddments tray are integrated in the center armrest (similar to E46/3).

ISOFIX for the rear seats is also included as standard equipment.

The seat backrests are released by means of an operating handle in the recess on the upper edge of the backrest. The released seat backrest is indicated by a red warning zone. The red warning zone disappears again into the recess when the backrest is folded back and locked correctly.

The rear seat backrests have two lock positions and are not adjustable.



Releasing Seat Backrest

Index	Explanation
1	Backrest Unlatched Indicator

The backs of the seat backrests are covered with carpet material (colour same as paneling in luggage compartment).

2 holders are provided on the back of the backrests, to which the luggage compartment roller cover can be fastened when the backrests are folded down. The partition net can be pulled out from here and attached to the front retaining fixtures in the headliner.

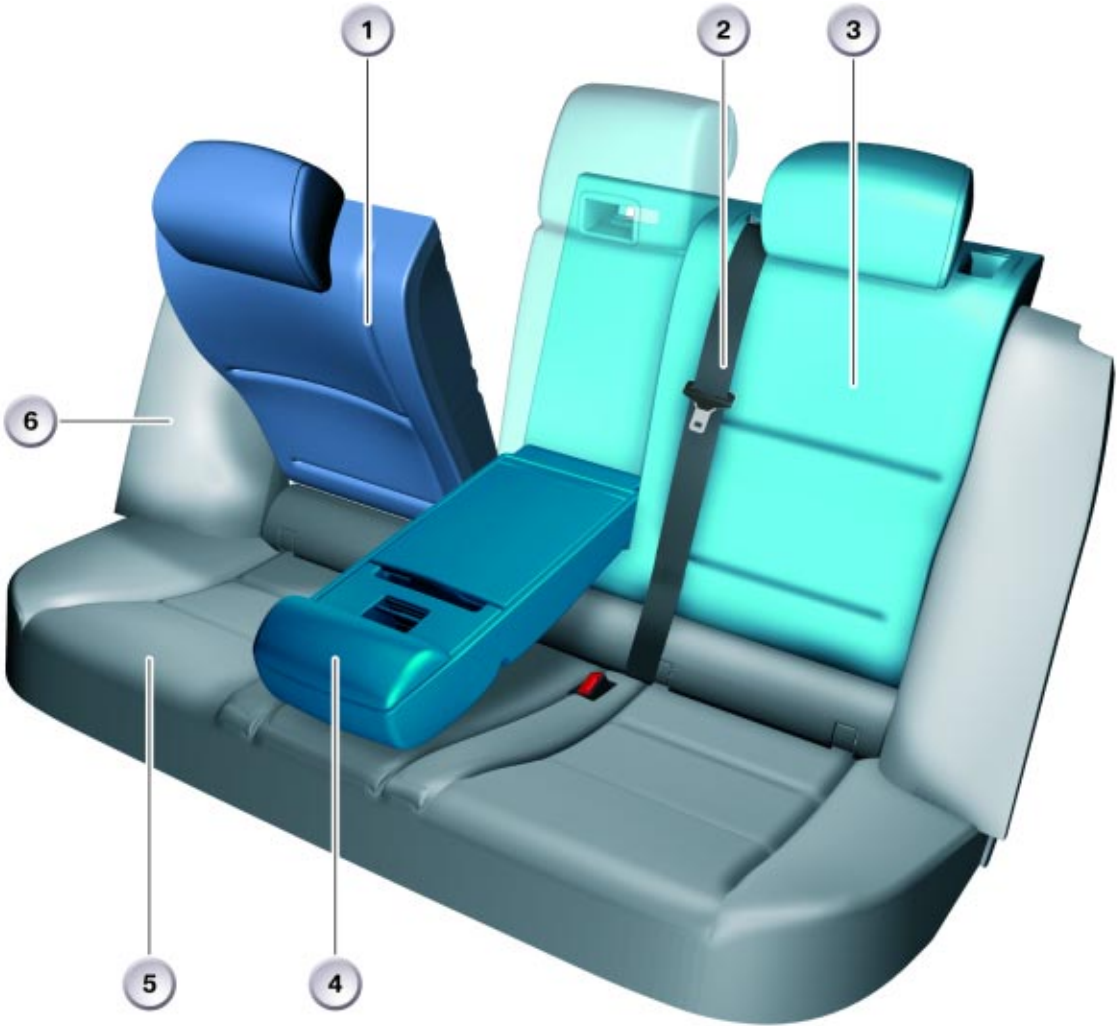

**Rear seats**

Index	Explanation
1	40% backrest
2	Middle 3-point seat belt
3	60% backrest
4	Center armrest
5	Bench seat (one-piece)
6	Side section (fixed)

## Rear Hatch

The rear hatch is made from steel. As on the E39/2 and E46/3, the rear window can be opened separately. In the event of an electrical fault, the rear hatch can be released from the luggage compartment by unclipping the cover from the tailgate and pulling an emergency release tab.



### Emergency Release of Rear Hatch

The rear window and rear hatch are connected to the body by means of hinges.

The rear hatch and rear window are screw-mounted on the respective hinges. The rear window can be adjusted to the level of the rear hatch by placing shims (0.5 mm, 1 mm and 2 mm) under the securing nuts.

The height levels of the rear hatch and rear windows are adjusted together with respect to the vehicle body.



Rear Hatch Hinge (Magnified View Shows Left Hinge)

Index	Explanation
1	Rear hatch hinge mounting on body
2	Hinged bracket for rear hatch
3	Rear window wiring harness
4	Hinged bracket for rear window
5	Rear window mounting on hinge
6	Rear hatch wiring harness

---

## Rear Window

As on the E39 Touring, the rear window can be opened independent of the rear hatch. The rear window is released from the outside by pressing the button on the rear window wiper. The rear window is locked by the central locking.

The opened rear window is held in position by a high tension spring on the hinge.

The rear window consists of green tempered safety glass with a thickness of approx. 5.0 mm with no sheet metal frame surround. The edge of the window features screen print/dots.

The center brake light is integrated in the rear spoiler. The water jet for the rear window is located in the center of the third brake light. The rear spoiler also contains the antenna amplifier with the antenna diversity module and the AM/FM4 antenna.

The FM1 - FM3 antennas are integrated in the electrically heated defogger zone on the rear window.



Rear Window Opened



Rear Tailgate Opened

## Rear Window Wiper

The rear window wiper concept and rear window lock are the same as on the E46/3. The functions of the rear window wiper are controlled by the KBM.

## Automatic Rear Hatch (HKL)

Automatic Tailgate Lift is available on vehicles ordered with the premium package option. This allows the tailgate to be raised and lowered automatically with the aid of a hydraulic actuator. The rear hatch lift is similar to the HKL system used on the rear trunk lid on the E65/66.

Automatic rear hatch operation is controlled by the rear hatch lift (HKL). The rear hatch lift (HKL) operated together with the KBM and CAS installed as standard.

The rear hatch lift is not active while driving but only when the vehicle is stationary.

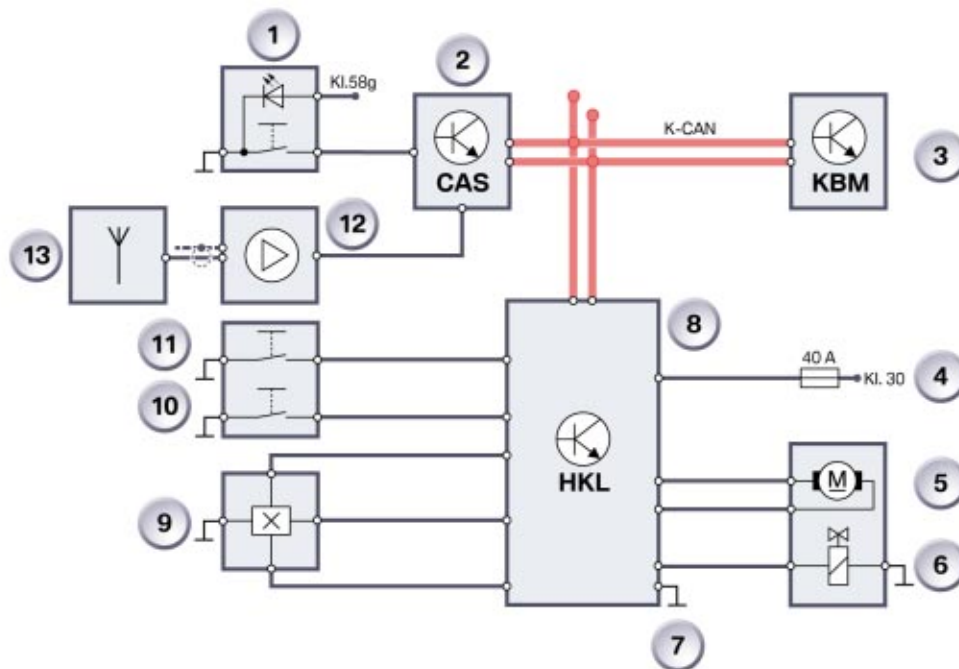

Block diagram HKL

Index	Explanation	Index	Explanation
1	Rear hatch button (in driver's footwell)	8	Rear hatch lift HKL
2	Car access system CAS	9	Hall sensor (angle sensor)
3	Basic body module KBM	10	Rear hatch button (on inside of rear hatch)
4	Terminal 30 (40 A fuse-protected)	11	Rear hatch button (on outside of rear hatch)
5	Electric motor for hydraulic pump	12	Antenna amplifier, FBD receiver
6	Hydraulic valve	13	FBD antenna
7	Ground connection (terminal 31)		



## System Components

The HKL system is made up of the following components:

- Electric motor for the hydraulic pump
- Hydraulic valve,
- Angle Hall sensor
- Control buttons
  - Rear hatch button on inside of rear hatch
  - Rear hatch button on outside of rear hatch
  - Rear hatch button on inside of vehicle
  - Rear hatch button on vehicle key

### Hydraulic System

The hydraulic system is self-bleeding and maintenance-free. The hydraulic unit is located on the driver's side of the luggage compartment behind the audio system amplifier.

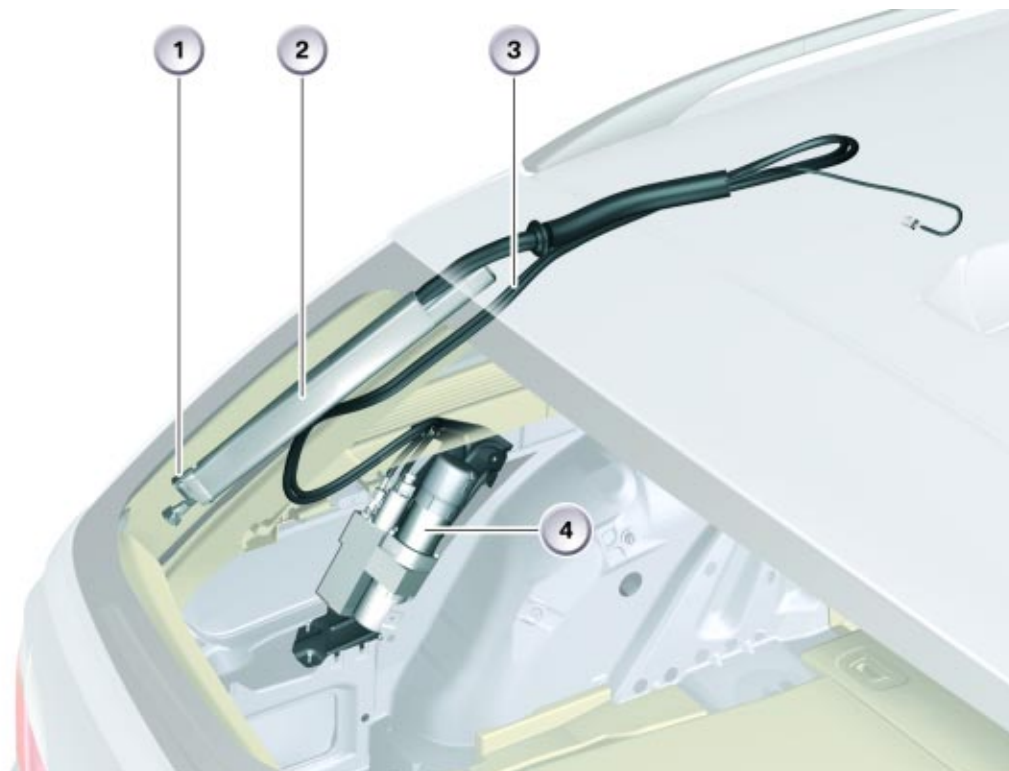

Overview of Hydraulic System for Opening Rear Hatch

Index	Explanation	Index	Explanation
1	Hall sensor (angle sensor)	3	Hydraulic lines
2	Hydraulic cylinder	4	Hydraulic unit



---

The hydraulic components in the system are:

- Hydraulic unit with hydraulic pump
- Hydraulic cylinder
- Hydraulic lines

The hydraulic pump in the hydraulic unit is driven by an electric motor that operates in two directions. The two operating directions are realized by a relay circuit in the HKL control module.

A repeat inhibit is included in the software to prevent overheating of the pump motor during frequent operation of the automatic rear hatch. The repeat inhibit is triggered after 2 minutes of continuous operation and is deactivated again after a cooling-down phase of 6 minutes.

A proportional valve is included in the hydraulic circuit. When not activated, the valve is open, i.e. the pressure in the hydraulic system is at the lowest level. This setting also enables the closing/opening of the rear hatch in case of system malfunction. When the valve is activated, the aperture becomes smaller and the pressure in the hydraulic system increases. The hydraulic cylinder is operated (piston or rod end depending on direction of rotation of the hydraulic pump) and the rear hatch is raised or lowered.

#### ■ Angle Hall Sensor

An angle Hall sensor is used for detecting the position of the rear hatch or detecting the opening angle of the rear hatch. A voltage value is output dependent on the opening angle of the rear hatch.

The angle Hall sensor produces an analog linear voltage signal back to the HKL control module for tailgate status.



Angle Hall Sensor



Angle Hall Sensor (mounted)

## System Operation

### ■ Opening and Closing Rear Hatch

The following options are available for opening/closing the rear hatch:

- Outside rear hatch button
- Inside rear hatch button (rear hatch opened)
- Rear hatch button on radio remote control key
- Pull down or raise rear hatch at recessed handgrip in rear hatch trim panel
- Rear hatch button in vehicle interior (not yet realized at series production launch)

### ■ Operating Rear Hatch Buttons on Outside/Inside

The rear hatch can be opened, stopped or closed by pressing the rear hatch button on the outside (just above the license plate) or inside (on tailgate sill trim with the rear hatch open).

The rear hatch can also be stopped or activated in any opened position. The buttons need only be pressed once to initiate activation up to the respective end position (rear hatch opened or closed). The drive stops automatically at the end positions.

The direction the rear hatch moves changes every second time the button is pressed:

**Example:** *Press tailgate button to unlock and raise tailgate*

*While the tailgate is being raised, press the button - the tailgate stops*

*Pressing the button again will cause the tailgate to reverse direction and now lower... and so on*

### ■ Activation Via Remote Control Services (FBD)

The rear hatch can be opened via key remote control (rear hatch button on key). The rear hatch button on the vehicle key must be pressed for longer than 1.6 seconds to open the rear hatch. The rear hatch opens completely (even when the button is subsequently released). The 1.6 second time delay is programmed in to avoid unwanted tailgate operation while for example placing key in a pocket/purse.

### ■ Secondary or Emergency Operation

In the event of the automatic function failing, the rear hatch can be opened and closed in the same way as a conventional, manually operated rear hatch without the need for additional measures.

The force required for this purpose is slightly higher than required for the rear hatch supported purely by the gas spring strut.

**Note:** **After being opened manually, the rear hatch should be opened and closed twice with the hydraulic system. This operation will bleed any air out of the hydraulic system.**

### ■ Adjusting Opening Height of the Tailgate

The opening height of the tailgate can be varied by using the vehicle settings menu in the iDrive system.

To access this setting select:

Vehicle Settings => Door Locks => Tailgate

The height adjustment can be changed by rotating the iDrive controller.



Tailgate Minimum Opening Height



Tailgate Maximum Opening Height

# General Vehicle Electrical Systems

## Bus System

The following changes have been implemented from April 2005 production:

- Addition of HKL (E61 only)
- Addition of EHC (E61 only)
- Replacement of SHD for MDS (E61 only)
- Lamp Module (LM) is on the PT-CAN
- Elimination of the AHL control unit

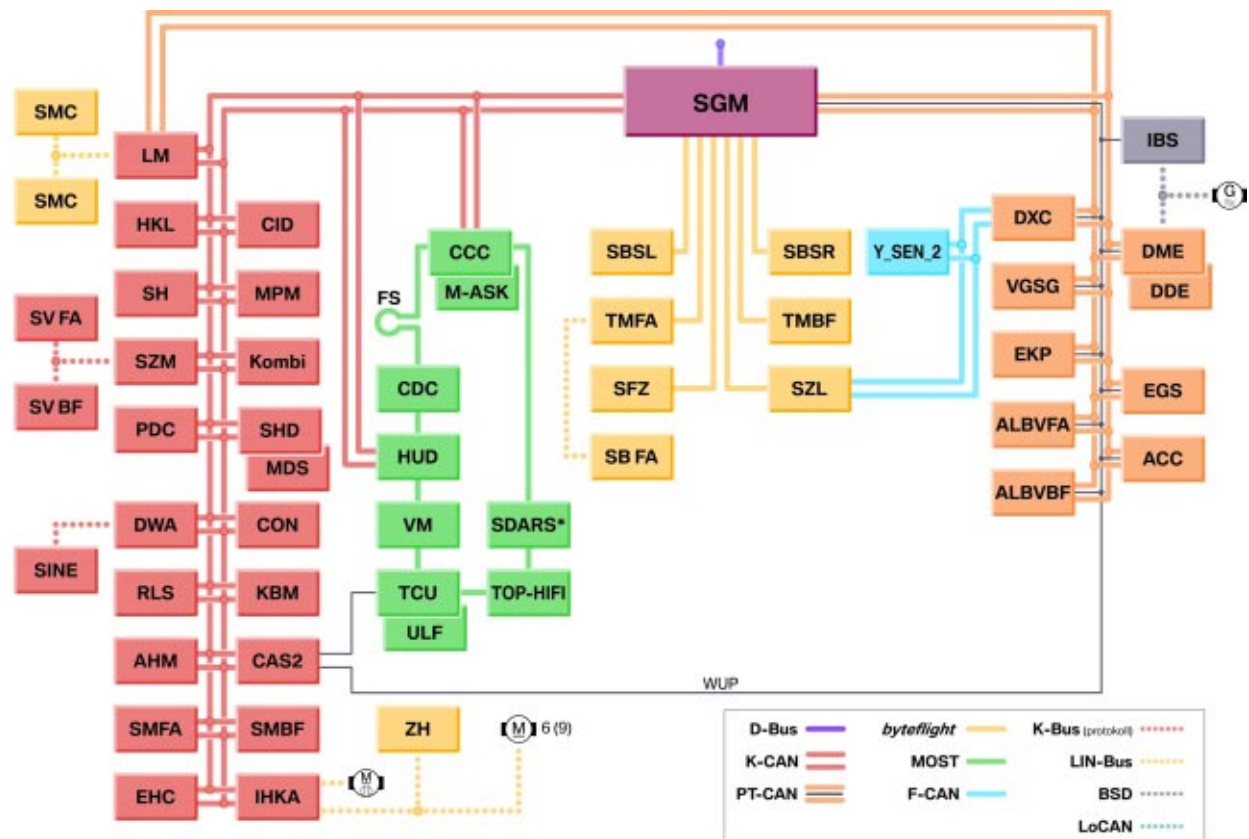

## E61 Bus Overview

## Car Communication Computer

The navigation system Professional now features a bird's-eye view or perspective map.

The icon bar on the left-hand side is a new feature. By selecting the corresponding icons, it is now possible to activate functions such as "start/end route guidance" or "change route criteria" out of the map view.

The functions that can be selected through the icons are listed in the following table.

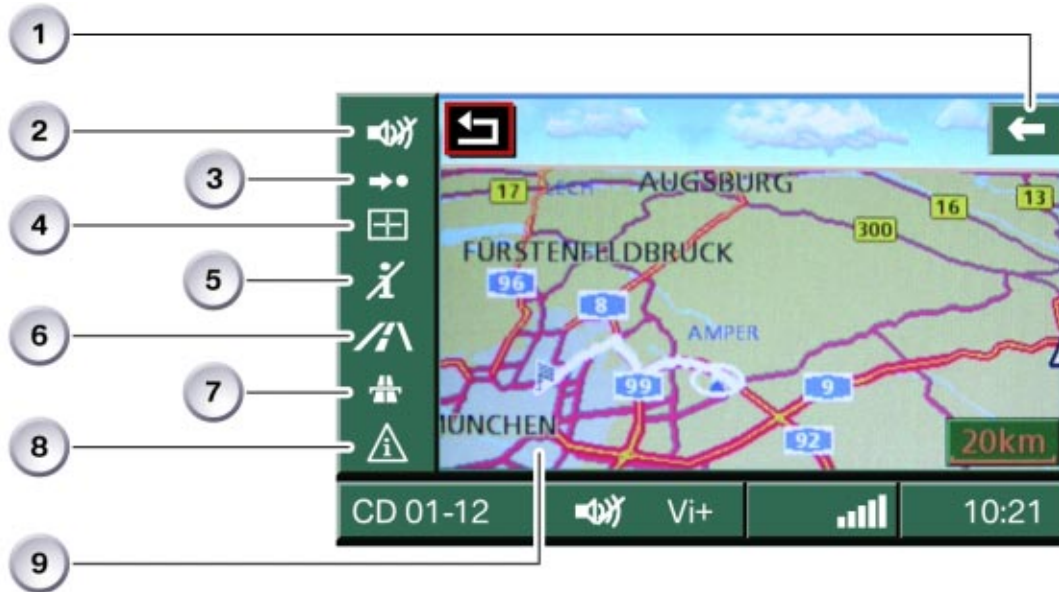

Navigation Menu With Bird's-eye View and Icon Bar

Index	Explanation
1	Arrow pointing towards destination(as the crow flies)
2	Voice announcements ON/OFF
3	Start/end route guidance
4	Select destination on map
5	Display information
6	Change map view
7	Change route criteria
8	Select traffic information
9	Perspective map presentation

## Antenna Systems

The heating conductor and antenna structures for 3 FM antennas are located on the inside of the rear window. Stranded wires are used to connect the antenna structures of the rear window.

AM reception is enabled with the aid of the AM sensor in the rear spoiler. A conductor of the split AM sensor is additionally used as a fourth FM antenna or FBD antenna. The AM sensor consists of two stranded wire conductors with lengths optimized for AM reception. The diversity components are connected by means of a 3-pin ELO plug.

The HBL interference suppression filter suppresses interference on the supply line of the third brake light (HBL) and of the rear window button line.

The rear window is powered via a rejecter circuit on the right-hand side of the rear window.

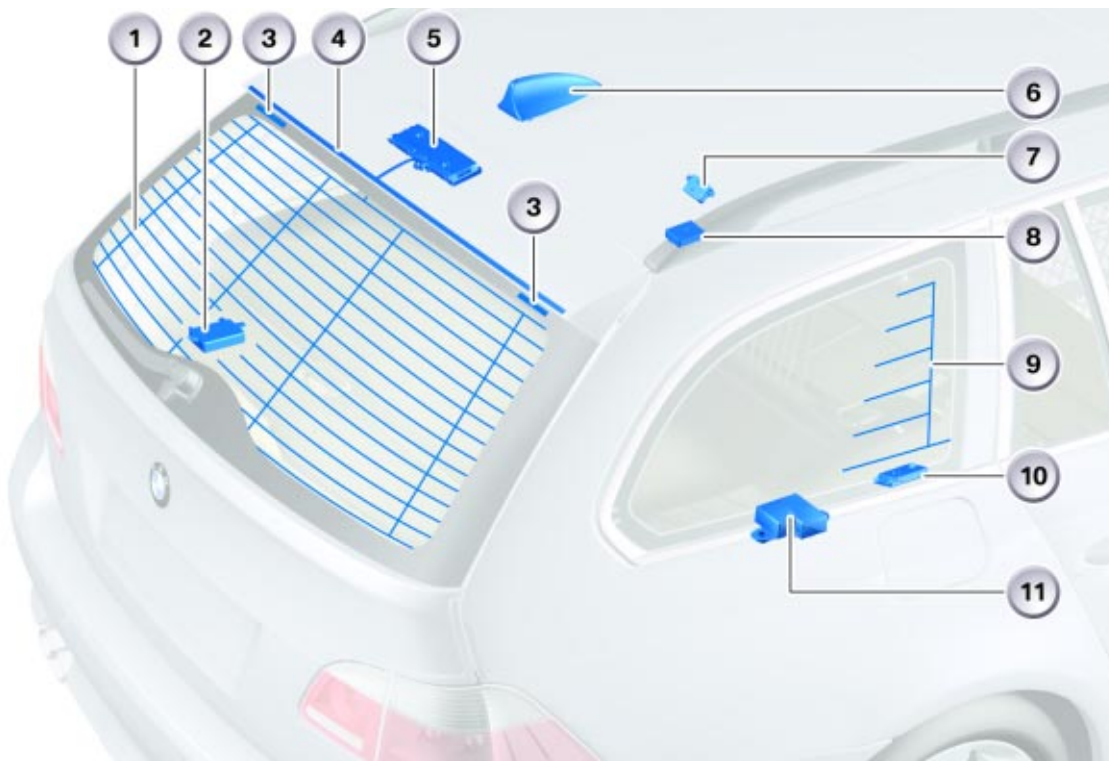

Index	Explanation	Index	Explanation
1	Rear window defogger with integrated FM antennas 1-3	7	Rejecter circuit, ground (filter)
2	Compensator	8	HBL suppression filter (for brake light)
3	Rejecter circuit, ground (filter)	9	TV antenna 2 (Not for US)
4	AM/FM4/FBD antenna	10	TV amplifier (Not for US)
5	Antenna amplifier with antenna diversity module	11	Telephone emergency call antenna
6	Roof antenna (telephone, GPS, SDARS)		



## Tail Light Cluster

The tail light cluster is a split unit. One part is located in the side panel and the other in the rear hatch. The tail lights are divided in 6 sections.



Tail light cluster

Index	Explanation	Index	Explanation
1	Direction Indicator light	5	Tail light/brake light
2	Two-stage brake light	6	Tail light/brake light
3	Reversing light	7	Side marker light
4	Rear Deflector		

Light	Quantity	Operating voltage	Output at 12 V
Tail light/brake light	2	6 V / 13.5 V	21 W 21 W
Tail light/brake light	2	6 V / 13.5 V	21 W 21 W
Third brake light	1	System voltage	0.5 W
Reversing light	2	13.5 V	16 W
Direction indicators	2	13.5 V	21 W
Rear fog light	2	13.5 V	16 W



### Replacing Reversing Light

The nut (2) must first be undone in order to replace the lamp bulbs for the reversing light. The holder is loosened a little and the complete unit can be detached from the rear hatch. Release the catch and remove the bulb carrier plate. When installing, ensure the seal is positioned correctly.



Index	Explanation
1	Bracket
2	Nut
3	Seal
4	Bulb Carrier Plate
5	Latch

## Control Unit Locations in Luggage Compartment



Control Units in Luggage Compartment, Left

Index	Explanation	Index	Explanation
1	TV antenna amplifier, left (not for US)	3	Top-HiFi amplifier, Top-HiFi
2	MOST fibre optics connector	4	Video module VM (not for US)



Control Units in Luggage Compartment, Right

Index	Explanation	Index	Explanation
1	TV antenna amplifier, right (not for US)	3	Rear power distribution box
2	Telephone emergency call antenna	4	Intelligent battery sensor (IBS)

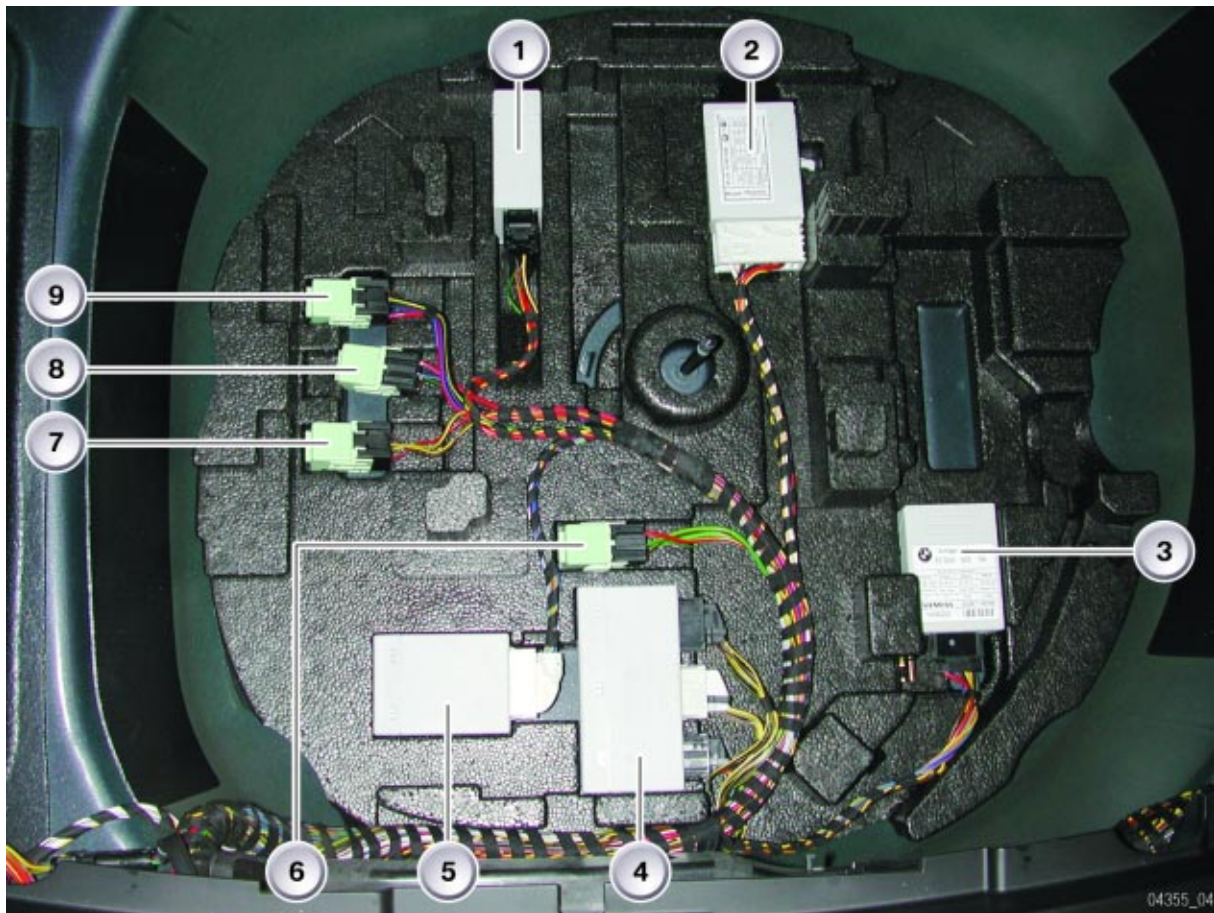

Index	Explanation	Index	Explanation
1	Micro-power module MPM	6	Relay, rear window wiper (not for US)
2	Rear hatch lift HKL	7	Relay, compressor for air suspension
3	Trailer module AHM	8	Load-shedding relay, electronic ampere control
4	Park distance control PDC	9	Relay, automatic soft-close
5	Electronic ride height control EHC		